



Lista de preturi 2018

Valabila de la 10 august 2018

LEI

Chei (chei fixe duble drepte, chei combinate, chei inelare dublu cotite, chei roti, chei reglabile, chei imbus)	Pag. 3
Capete si truse capete chei tubulare si accesorii (1/4", 3/8", 1/2")	Pag. 6
Clesti (clesti combinati, clesti tais lateral, clesti reglabili, clesti cuie, clesti plasa sarma, clesti tevi, multitool)	Pag. 11
Cuttere (cuttere universale, lame cutter, cutere de securitate cu lama retractabila si autoretractabila)	Pag. 13
Surubelnite (surubelnite late, surubelnite Phillips, surubelnite Pozidrive, testere tensiune, seturi surubelnite)	Pag. 14
Dalti (dalti pentru lemn, dalti si spituri pentru constructii, dalti zidarie)	Pag. 15
Instrumente de masura (rulete, metre lemn, nivele)	Pag. 16
Fierastraie	Pag. 16
Ciocane (ciocane lacatuserie, baroase, ciocane dulgher, ciocane din cauciuc)	Pag. 17
Preducele	Pag. 17
Topoare, tarnacoape	Pag. 17
Leviere, scule de indoit fier beton	Pag. 18
Mistrii, gletiere	Pag. 18
Menghine	Pag. 19
Truse scule	Pag. 19
Genti pentru scule (centuri din piele pentru scule, genti ABS)	Pag. 19
Biti si accesorii	Pag. 21
Accesorii scule electrice (mandrine cu cheie, dornuri mandrine, chei mandrine)	Pag. 22
Panze circulare pentru lemn	Pag. 22
Materiale promotionale	Pag. 23

7215/2
Cheie tubulara pentru roti

• material: crom vanadiu; acoperire: fosfatata, pretul nu include tija de antrenare

Cod	Dimensiuni	L	DØ	D3Ø	Pret
691922	19x22	360	20.0	22.0	72,17
692224	22x24	360	20.0	22.0	72,17
692427	24x27	360	21.5	22.0	72,17
692730	27x30	360	21.5	22.0	72,17
692733	27x33	360	21.5	22.0	72,17
693032	30x32	360	21.5	22.0	72,17

• material: otel carbon; acoperire: vopsire, pretul nu include tija de antrenare

Cod	Dimensiuni	L	DØ	D3Ø	Pret
900385	19x22	405	26.0	19.0	71,42
900386	22x24	405	26.0	19.0	75,08
900387	24x27	405	26.0	19.0	80,57
900388	27x30	405	26.0	19.0	84,24
900389	27x33	405	26.0	19.0	89,73
900390	30x32	405	26.0	19.0	91,56

7250
Cheie reglabila

- material: crom vanadiu
- acoperire cromare conform EN12540
- capete polizate
- cu scala
- forjata, calire si revenire totala
- in conformitate cu standardul ISO 6787

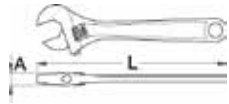

Cod	mm	L	A	●	Pret
621777	250	254	16,9	32	91,22

7251
Cheie reglabila

- material: crom vanadiu
- forjata, calire si revenire totala
- acoperire prin brunare
- rotire stanga
- cu scala
- in conformitate cu standardul ISO 6787

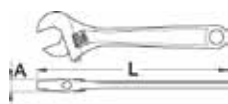

Cod	mm	L	A	●	Pret
900468	205	205	14,4	25	23,26
900469	255	255	16,9	30	30,03

7176
Cheie pipa cu 6 laturi

- material: #45
- tratate
- acoperire: cromare

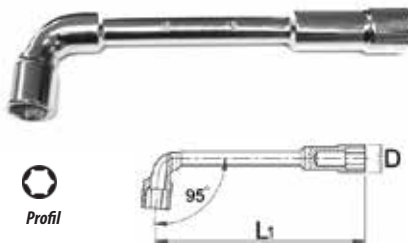

Cod	D	L	Ø	G	Pret
71760006	6	105	10	44	8,88
71760007	7	105	11	47	8,88
71760008	8	129	12	76	8,88
71760009	9	129	13	78	9,59
71760010	10	143	15	123	10,30
71760011	11	143	16	125	11,37
71760012	12	154	17	161	12,25
71760013	13	159	20	186	13,15
71760014	14	174	21	226	15,45
71760015	15	180	22	236	18,11
71760016	16	198	24	340	19,18
71760017	17	198	25	360	22,20
71760018	18	214	27	441	26,82
71760019	19	214	29	445	29,66
71760020	20	225	30	495	32,50
71760021	21	225	30	487	34,27
71760022	22	240	32	590	37,83
71760023	23	240	33	640	43,69
71760024	24	247	35	713	45,99
71760027	27	290	37	867	64,99
71760030	30	323	42	1257	89,85
71760032	32	332	44	1434	102,46

72880
Set de chei locas hexagonal in suport de plastic

- material: crom vanadiu
- tratate
- acoperire prin brunare
- conform cu standardul ISO 2936



Cod	Art.	Nr. piese	Pret
72880	72880 PH	2,5-10 / 7	20,97
7220/4 (2,5, 3, 4, 5, 6, 8, 10)			

72881
Set de chei locas hexagonal lungi cu cap sferic in suport de plastic

- material: crom vanadiu
- tratate
- acoperire prin brunare
- conform cu standardul ISO 2936



Cod	Art.	Nr. piese	Pret
72881	72881 PH	2,5-10 / 7	30,83
7220/4SL (2,5, 3, 4, 5, 6, 8, 10)			

72882
Set de chei locas hexagonal in suport de plastic

- material: crom vanadiu
- tratate
- acoperire prin brunare
- conform cu standardul ISO 2936



Cod	Art.	Nr. piese	Pret
72882	72882 PH	1,5-10 / 9	23,78
7220/4 (1,5, 2, 2,5, 3, 4, 5, 6, 8, 10)			

72883
Set de chei locas hexagonal lungi cu cap sferic in suport de plastic

- material: crom vanadiu
- tratate
- acoperire prin brunare
- conform cu standardul ISO 2936



Cod	Art.	Nr. piese	Pret
72883	72883 PH	1,5-10 / 9	33,99
7220/4SL (1,5, 2, 2,5, 3, 4, 5, 6, 8, 10)			

72878
Set de chei locas TORX® in suport de plastic

- material: crom vanadiu
- tratate
- acoperire prin brunare



Cod	Art.	Nr. piese	Pret
72878	72878 PH	TX10-TX40 / 7	21,49
7220/4TX (TX10, TX15, TX20, TX25, TX27, TX30, TX40)			

72879
Set de chei locas TORX® lungi cu cap sferic in suport de plastic

- material: crom vanadiu
- tratate
- acoperire prin brunare



Cod	Art.	Nr. piese	Pret
72879	72879 PH	TX10-TX40 / 7	31,34
7220/4TXSL (TX10, TX15, TX20, TX25, TX27, TX30, TX40)			

7188H.10-1/4"

Set 10 cleme pentru capete chei tubulare 1/4"

- material: oțel SK-7
- acoperire: nichelare
- include 10 cleme pentru patrat de antrenare de 1/4"

1/4"



Cod	"	Pret
900431	1/4"	2,90

7188H6P11

Set capete chei tubulare 4-14 mm / 11 piese cu sina 1/4"

- include capete chei tubulare 1/4": 4, 5, 6, 7, 8, 9, 10, 11, 12, 13, 14 mm
- sina metalica 200 mm
- cleme 1/4" (11 bucati)



Cod	Art.	Nr. piese	Pret
900470	7188H6P11	11	33,16
7188-1/4" (4, 5, 6, 7, 8, 9, 10, 11, 12, 13, 14 mm)			

7187HTXP8

Set capete chei tubulare cu profil TORX TX8-TX40 / 8 piese cu sina 1/4"

- include capete chei tubulare 1/4": TX8, TX10, TX15, TX25, TX25, TX27, TX30, TX40
- sina metalica 200 mm
- cleme 1/4" (8 bucati)



Cod	Art.	Nr. piese	Pret
900471	7187HTXP8	8	31,77
7187TX-1/4" (TX8, TX10, TX15, TX20, TX25, TX27, TX30, TX40)			

7187HHXP7

Set capete chei tubulare cu profil hexagon exterior HX3-HX10 / 7 piese cu sina 1/4"

- include capete chei tubulare 1/4": HX3, HX4, HX5, HX6, HX7, HX8, HX10
- sina metalica 200 mm
- cleme 1/4" (7 bucati)



Cod	Art.	Nr. piese	Pret
900472	7187HHXP7	7	31,29
7187HX-1/4" (HX3, HX4, HX5, HX6, HX7, HX8, HX10)			

7189HEP6

Set capete chei tubulare cu profil TORX interior E4-E10 / 6 piese cu sina 1/4"

- include capete chei tubulare 1/4": E4, E5, E6, E7, E8, E10
- sina metalica 200 mm
- cleme 1/4" (6 bucati)



Cod	Art.	Nr. piese	Pret
900473	7189HEP6	6	24,11
7189-1/4" (E4, E5, E6, E7, E8, E10)			

7188BI6P15

Trusa capete chei tubulare si accesorii 1/4" in cutie de plastic



Cod	Art.	Nr. piese	Pret
616273	7188BI6P15	15	131,87
7188 (4, 5, 6, 7, 8, 9, 10, 11, 12, 13, 14 mm), 7188.1 1/4" (157 mm), 7188.4 1/4" (150 mm), 7188.5 1/4" (50 mm), 7188.3 1/4" (120 mm)			

7238 3/8"

Capete chei tubulare 6 laturi 3/8"

- material: crom vanadiu
- acoperire cromare conform EN12540
- polizate
- forjata, calire si revenire totala
- executie in concordanta cu standardul ISO 2725-1



Cod	mm	L	D1	D2	T	Pret
616182	6	28	9,9	16,9	4	2,82
616183	7	28	10,6	16,9	4	2,82
616184	8	28	11,8	16,9	5	2,82
616185	9	28	13,2	16,9	5	2,82
616186	10	28	14,5	16,9	6	2,82
616187	11	28	15,7	16,9	7	2,82
616188	12	28	16,9	16,9	8	2,82
616189	13	28	17,9	17,9	8	2,82
616190	14	28	19,6	19,6	10	3,00
616191	15	28	21,0	21,0	10	3,52
616192	16	30	21,8	21,8	10	3,52
616193	17	30	23,4	23,4	10	3,70
616194	18	30	24,7	21,0	12	4,23

7186.4/2 3/8"

Cheie de bujii cu patrat de 3/8"

- material: crom vanadiu
- forjata, calire si revenire totala
- acoperire cromare conform EN12540



Cod	mm	D	L	HEX	G	Pret
616197	16	22	63	19	68	17,18
616198	19	26	63	22	68	19,52
616196	21	27	66	19	68	22,07

7238.1 3/8"

Antrenor cu clichet reversibil 3/8"

- material: compozitie speciala pentru calire revenire
- maner ergonomic rezistent bimaterial
- 72 de dinti
- corp forjat
- tratament termic total
- suprafata: cromata in concordanta cu standardul EN 12540
- executie in concordanta cu standardul ISO 3315
- Standard: ISO 3315 No. 257



Cod	"	L	A	B	Pret
616195	3/8"	196	30	35	65,88

7238.4 3/8"

Prelungitor lung 3/8"

- material: crom vanadiu
- acoperire cromare conform EN12540
- forjata, calire si revenire totala
- produs in conformitate cu standardul ISO 3316
- Standard: ISO 3316 No. 204



Cod	"	L	D1	D2	Pret
616199	3/8"	250	12,5	18	12,51

7238.5 3/8"

Prelungitor scurt 3/8"

- material: crom vanadiu
- acoperire cromare conform EN12540
- forjata, calire si revenire totala
- produs in conformitate cu standardul ISO 3316
- Standard: ISO 3316 No. 204



Cod	"	L	D1	D2	Pret
616200	3/8"	125	12,5	18	7,22

7238.6 3/8"

Intermediar cardanic 3/8"

- material: crom vanadiu
- forjată, calire și revenire totală
- acoperire cromare conform EN12540
- produs în conformitate cu standardul ISO 3316



Cod	"	L	D	Pret
900410	3/8"	54	19	15,89

7238.7 3/8"

Adaptor 3/8"

- material: crom vanadiu
- forjată, calire și revenire totală
- acoperire cromare conform EN12540
- produs în conformitate cu standardul ISO 3316



Cod	"	L	D	Pret
900405	3/8" - 1/4"	38	17	4,07
900406	3/8" - 1/2"	32	18	6,59

7238H-3/8"

Sina metalica cu 10 cleme pentru capete chei tubulare 3/8"

- material: oțel
- acoperire: nichelare
- include 10 cleme pentru patrat de antrenare de 3/8"



Cod	L	Pret
900423	200	7,00
900424	250	7,46
900425	350	8,64
900426	400	10,21

7238H6P13

Set capete chei tubulare 6 laturi 6-18 mm / 13 piese cu sina 3/8"

- include capete chei tubulare 3/8": 6, 7, 8, 9, 10, 11, 12, 13, 14, 15, 16, 17, 18 mm
- sina metalica 350 mm
- cleme 3/8" (13 bucati)



Cod	Art.	Nr. piese	Pret
900474	7238H6P13	13	50,15

7238-3/8" (6, 7, 8, 9, 10, 11, 12, 13, 14, 15, 16, 17, 18 mm)

7238H.10-3/8"

Set 10 cleme pentru capete chei tubulare 3/8"

- material: oțel SK-7
- acoperire: nichelare
- include 10 cleme pentru patrat de antrenare de 3/8"



Cod	"	Pret
900432	3/8"	3,30

7238BI6P16

Trusa capete chei tubulare si accesorii 3/8" in cutie de plastic



Cod	Art.	Nr. piese	Pret
616284	7238BI6P16	16	148,15

7238 (6, 7, 8, 9, 10, 11, 12, 13, 14, 15, 16, 17, 18 mm), 7238.1 3/8" (200 mm), 7238.4 1/4" (250 mm), 7238.5 1/4" (125 mm)

7190 1/2"

Capete chei tubulare 6 laturi 1/2"

- material: crom molibden
- forjată, calire și revenire totală
- acoperire cromare conform EN12540
- polizate
- executie în concordanță cu standardul ISO 2725-1



Cod	mm	L	D1	D2	T	Pret
616087	10	38	15	22,9	12	4,80
616088	11	38	16,3	22,9	12	4,80
616089	12	38	17,9	22,9	12	4,83
616090	13	38	18,8	22,9	12	4,83
616091	14	38	19,7	22,9	12	4,83
616092	15	38	20,4	22,9	12	4,83
616093	16	38	22,9	21,5	12	4,83
616094	17	38	24,3	22	12	5,19
616095	18	38	25,5	23	12	7,32
616096	19	38	26,8	24	14	7,32
616097	20	38	28,1	24	14	7,32
616098	21	38	29,3	25	14	7,32
616099	22	38	30,4	25	14	7,32
616100	23	40	31,7	26	14	8,91
616101	24	42	33,1	28	16	8,91
616102	27	43	37	30	18	14,80
616103	30	46	40,7	34	22	14,80
616104	32	46	43,2	36	22	15,70

7192 HX 1/2"

Capete chei tubulare 1/2" cu profil hexagon exterior

- material: capete chei tubulare: crom-vanadiu, acoperire cromare
- bit: oțel special de scule
- produs conform standardului DIN 7422
- capul cheii este tratat în întregime



Cod	HEX	L	L1	D	Pret
616110	HX 4	23	60	24	7,57
616111	HX 5	23	60	24	7,57
616112	HX 6	23	60	24	7,57
616113	HX 8	23	60	24	7,57
616114	HX 10	23	60	24	8,27
616115	HX 12	23	60	24	9,52
616116	HX 14	23	60	24	9,86
616117	HX 17	24	60	20	11,27

7192 SL 1/2"

Capete chei tubulare 1/2" cu profil lat

- material: capete chei tubulare: crom-vanadiu, acoperire cromare
- bit: oțel special de scule
- capul cheii este tratat în întregime



Cod	a	b	D	L	L1	Pret
616138	1,2	8,0	22,9	63	27	7,40
616139	1,6	10,0	22,9	63	27	8,98
616140	2,0	12,0	22,9	63	27	10,04

7190 TX 1/2"

Capete chei tubulare 1/2" cu profil TORX® exterior

- material capete chei tubulare: crom molibden
- bit: oțel special de scule
- capul cheii este tratat în întregime



Cod	Phillips	D	L	L1	Pret
616118	TX 20	22,9	52	16	9,16
616119	TX 25	22,9	52	16	8,45
616120	TX 27	22,9	52	16	8,45
616121	TX 30	22,9	52	16	8,45
616122	TX 40	22,9	52	16	8,45
616123	TX 45	22,9	52	16	8,45
616124	TX 50	22,9	52	16	8,45
616125	TX 55	22,9	57	21	9,68
616126	TX 60	22,9	57	21	10,39

7192 PH 1/2"

Capete chei tubulare 1/2" cu profil Phillips

- material capete chei tubulare: crom molibden
- bit: otel special de scule
- capul cheii este tratat in intregime

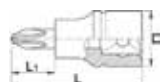

Cod	Phillips	D	L	L1	Pret
616136	PH 2	22,9	54	18	7,40
616137	PH 3	22,9	54	18	7,40

7191 E 1/2"

Capete chei tubulare 1/2" cu profil TORX® interior

- material: crom vanadiu
- forjata, calire si revenire totala
- acoperire cromare conform EN12540
- polizate

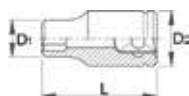

Cod	TORX	D2	D1	L	G	Pret
616127	E 10	22	14	38	58	4,75
616128	E 11	22	15	38	52	4,75
616129	E 12	22	15	38	55	4,75
616130	E 14	22	17	38	57	5,13
616131	E 16	22	19	38	62	5,33
616132	E 18	22	21	38	78	6,09
616133	E 20	26	23	40	95	6,85
616134	E 22	26	25,3	40	105	6,85
616135	E 24	28	27,3	40	119	6,85

7190.1 1/2"

Antrenor cu clichet reversibil 1/2"

- material: compozitie speciala pentru calire revenire
- maner ergonomic rezistent bimaterial
- 72 de dinti
- corp forjat
- tratament termic total
- suprafata: cromata in concordanta cu standardul EN 12540
- executie in concordanta cu standardul ISO 3315
- Standard: ISO 3315 No. 257

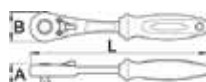

Cod	"	L	A	B	Pret
616105	1/2"	254	36	45	95,44

7190.3 1/2"

Antrenor cu parghie glisanta 1/2"

- material: crom vanadiu
- suprafata: cromata in concordanta cu standardul EN 12540
- executie in concordanta cu standardul ISO 3315
- tratament termic total
- Standard: ISO 3315 No. 253



Cod	"	L	A	D1	D2	Pret
616109	1/2"	250	45	14	25,5	24,80

7190.5 1/2"

Prelungitor scurt 1/2"

- material: crom vanadiu
- acoperire cromare conform EN12540
- forjata, calire si revenire totala
- produs in conformitate cu standardul ISO 3316
- Standard: ISO 3316 No. 204



Cod	"	L	D1	D2	Pret
616108	1/2"	75	16,8	24	7,57
616107	1/2"	125	16,8	24	10,04

7190.7 1/2"

Adaptor 1/2"-3/8"

- material: crom vanadiu
- forjata, calire si revenire totala
- acoperire cromare conform EN12540
- produs in conformitate cu standardul ISO 3316



Cod	"	L	D	Pret
900408	1/2" - 3/8"	38	23	6,59

7190.6 1/2"

Intermediar cardanic 1/2"

- material: crom vanadiu
- acoperire cromare conform EN12540
- forjata, calire si revenire totala
- produs conform standardului ISO 3316



Cod	"	L	D	Pret
616106	1/2"	75,5	23	18,32

7190H-1/2"

Sina metalica cu 10 cleme pentru capete chei tubulare 1/2"

- material: otel
- acoperire: nichelare
- include 15 cleme pentru patrat de antrenare de 1/2"



Cod	L	Pret
900427	200	7,38
900428	250	7,85
900429	350	9,03
900430	400	10,60

7190H.10-1/2"

Set 10 cleme pentru capete chei tubulare 1/2"

- material: otel SK-7
- acoperire: nichelare
- include 10 cleme pentru patrat de antrenare de 1/2"



Cod	"	Pret
900433	1/2"	3,68

7190H6P11

Set capete chei tubulare 6 laturi 10-32 mm / 11 piese cu sina 1/2"

- include capete chei tubulare 1/2": 10, 12, 13, 14, 17, 19, 22, 24, 27, 30, 32 mm
- sina metalica 400 mm
- cleme 1/2" (11 bucati)



Cod	Art.	Nr. piese	Pret
900585	7190H6P11	11	104,30
7190-1/2" (10, 12, 13, 14, 17, 19, 22, 24, 27, 30, 32 mm)			

7190H6P9

Set capete chei tubulare 6 laturi 10-24 mm / 9 piese cu sina 1/2"

- include capete chei tubulare 1/2": 10, 12, 13, 14, 17, 19, 21, 22, 24 mm
- sina metalica 400 mm
- cleme 1/2" (9 bucati)



Cod	Art.	Nr. piese	Pret
900586	7190H6P9	9	65,93
7190-1/2" (10, 12, 13, 14, 17, 19, 21, 22, 24 mm)			

7192HTXP9

Set capete chei tubulare cu profil TORX TX20-TX60 / 9 piese cu sina 1/2"

- include capete chei tubulare 1/2" TX20, TX25, TX27, TX30, TX40, TX45, TX50, TX55, TX60
- sina metalica 250 mm
- cleme 1/2" (9 bucati)



Cod	Art.	Nr. piese	Pret
900477	7192HTXP9	9	87,42
7192TX-1/2" (TX20, TX25, TX27, TX30, TX40, TX45, TX50, TX55, TX60)			

7189/91HEP14

Set capete chei tubulare cu profil TORX interior E4-E24 / 14 piese cu sina 1/4" si 1/2"

- include capete chei tubulare 1/4": E4, E5, E6, E7, E8
- include capete chei tubulare 1/2" E10, E11, E12, E14, E16, E18, E20, E22, E24
- sina metalica 400 mm
- cleme 1/4" (5 bucati)
- cleme 1/2" (9 bucati)



Cod	Art.	Nr. piese	Pret
900587	7189/91HEP14	9	78,06
7189E (E4, E5, E6, E7, E8) 7191E (E10, E11, E12, E14, E16, E18, E20, E22, E24)			

7192HX/9

Trusa capete chei tubulare 1/2" in cutie de plastic



Cod	Art.	Nr. piese	Pret
616278	7192HX/9	9	102,00
7192 TX 1/2" (TX 20, TX 25, TX 27, TX 30, TX 40, TX 45, TX 50, TX 55, TX 60)			

7191HEP9

Set capete chei tubulare cu profil TORX interior E10-E24 / 9 piese cu sina 1/2"

- include capete chei tubulare 1/2" E10, E11, E12, E14, E16, E18, E20, E22, E24
- sina metalica 250 mm
- cleme 1/2" (9 bucati)



Cod	Art.	Nr. piese	Pret
900478	7191HEP9	9	58,84
7191 E-1/2" (E10, E11, E12, E14, E16, E18, E20, E22, E24)			

7190BI6P23

Trusa capete chei tubulare si accesorii 1/2" in cutie de plastic



Cod	Art.	Nr. piese	Pret
616281	7190BI6P23	23	331,62
7190 1/2" (10, 11, 12, 13, 14, 15, 16, 17, 18, 19, 20, 21, 22, 23, 24, 27, 30, 32), 7190.1 1/2" (260 mm), 7190.5 1/2" (75 mm, 125 mm), 7190.3 1/2" (250 mm), 7190.6 1/2" (75 mm)			

7190/2BI6P23

Trusa capete chei tubulare si accesorii 1/2" in cutie de plastic



Cod	Art.	Nr. piese	Pret
616282	7190/2BI6P23	23	342,28
7190 1/2" (10, 13, 17, 19, 24), 7190.1 1/2" (260 mm), 7190.5 1/2" (75 mm), 7190.3 1/2" (250 mm), 7192 HX 1/2" (HX 4, 5, 6, 8, 10, 12), 7192 TX 1/2" (TX 20, 25, 27, 30), 7192 PH 1/2" (PH 1, 2), 7192 SL 1/2" (SL 1.2x8, 1.6x10, 2.0x12)			

7190HHXP8

Set capete chei tubulare cu profil hexagon exterior HX4-HX17 / 8 piese cu sina 1/2"

- include capete chei tubulare 1/2" HX4, HX5, HX6, HX8, HX10, HX12, HX14, HX17
- sina metalica 250 mm
- cleme 1/2" (8 bucati)



Cod	Art.	Nr. piese	Pret
900476	7191HEP8	8	76,32
7192HX-1/2" (HX4, HX5, HX6, HX8, HX10, HX12, HX14, HX17)			

7191E/9

Trusa capete chei tubulare 1/2" in cutie de plastic



Cod	Art.	Nr. piese	Pret
616279	7191E/9	9	92,67
7191 E 1/2" (E 10, E 11, E 12, E 14, E 16, E 18, E 20, E 22, E 24)			

7190BI6P17

Trusa capete chei tubulare si accesorii 1/2" in cutie de plastic



Cod	Art.	Nr. piese	Pret
616283	7190BI6P17	17	296,20
7190 1/2" (10, 12, 13, 14, 16, 17, 19, 22, 24), 7190.1 1/2" (260 mm), 7190.5 1/2" (75 mm, 125 mm), 7190.3 1/2" (250 mm), 7190.6 1/2" (75 mm), 7238L 3/8" (16, 19, 21)			

7408 BI

Clește combinat cu maner bimaterial

- material: compoziție specială pentru calire revenire
- tratat complet
- partile taietoare tratate prin inducție
- cap vopsit
- acoperire: fosfatate
- maner bimaterial pentru condiții grele
- în conformitate cu standardul ISO 5746



Cod	L	B	C	A	Pret
74060160	160	24	35	9,5	25,92
74060180	180	27	38	10	30,19
74060200	200	29	41	10,5	33,01

7462 BI

Clește cu tais lateral cu maner bimaterial

- material: compoziție specială pentru calire revenire
- tratat complet
- partile taietoare tratate prin inducție
- cap vopsit
- acoperire: fosfatate conform cu standardul DIN 12476
- maner bimaterial pentru condiții grele
- în conformitate cu standardul ISO 5749

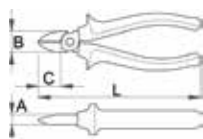

Cod	L	B	C	A	Pret
74620160	160	22,5	10	22	25,21

7441

Clește reglabil cu falci întrepătrunse și maner plastizolat

- material: crom vanadiu
- tratat complet
- suprafața de lucru tratată prin inducție
- maner de plastic
- deschiderea falcii reglabilă în 7 poziții
- în conformitate cu standardul ISO 8976



Cod	L	A	●	Pret
621774	240	7,5	35	48,25

7482

Clește cu gura în S la 45° pentru instalatori

- material: crom vanadiu, tratat complet, vopsit roșu
- falci danturate tratate prin inducție
- falcele asigură o blocare bună a suprafețelor plate semirotunde și rotunde
- în conformitate cu standardul DIN 5234 forma C

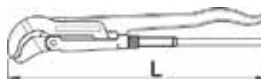

Cod	"	L	●	Pret
621845	2"	550	80	159,11

7530

Clește de cuie

- material: compoziție specială pentru calire revenire
- tratat complet
- partile taietoare tratate prin inducție
- cap vopsit
- acoperire: fosfatate conform cu standardul DIN 12476
- conform cu standardul ISO 9243
- standard: DIN ISO 9243 tip A

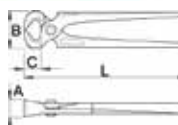

Cod	L	B	C	A	G	Pret
75300160	160	46	22,0	16,0	242,0	17,28
75300180	180	50	23,0	21,0	309,0	19,32
75300200	200	54	25,0	24,0	427,0	22,39

- material: inox 420, maner de aluminiu
- lungime deschis: 16.5 cm

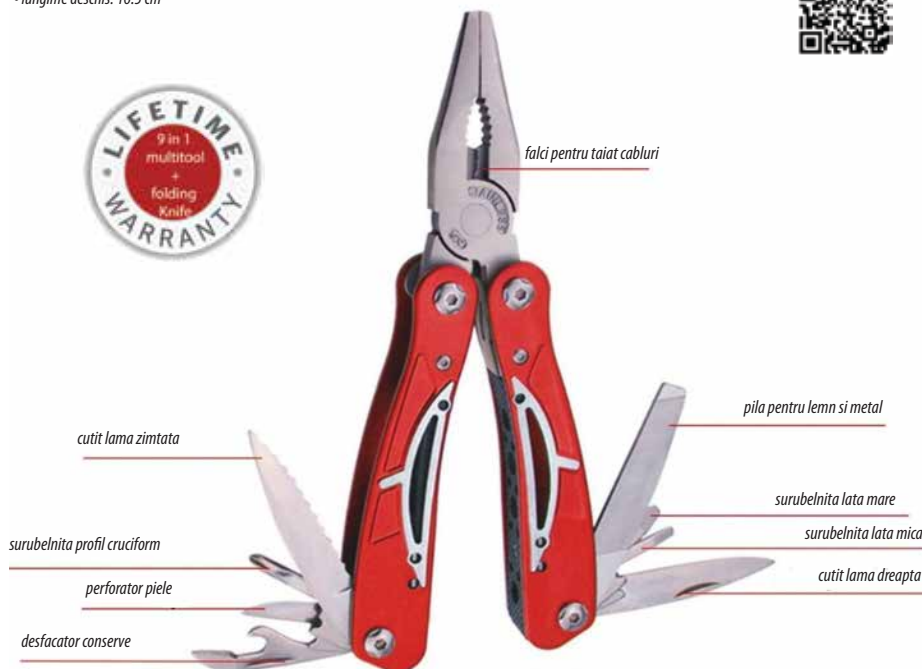

7531

Clește pentru plasa de sarma

- material: compoziție specială pentru calire revenire
- tratat complet
- util pentru îndoirea și sertizarea sarmelor
- cap vopsit
- acoperire: fosfatate conform cu standardul DIN 12476
- în concordanță cu standardul ISO 9242
- standard: DIN ISO 9243

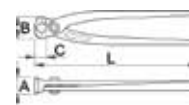

Cod	L	B	A	C	G	Pret
75310224	224	30	23	17	333	24,42

7556F

Set clește multitool cu briceag

- clește multifuncțional cu 9 operații
- briceag pliabil



Cod	L	Pret
7556F	165	80,33

7556F.1

Clește multifuncțional cu 9 operații

- material: inox 420 , maner de aluminiu
- lungime 16.5 cm
- surubelnita profil cruciform
- surubelnita lata mare
- surubelnita lata mica
- cutit lama dreapta
- cutit lama zimtata
- pila pentru lemn si metal
- lama cutit ascutit
- perforator piele
- cleste normal
- falci taiat cabluri
- defacator conserve
- cutit



Cod	L	Pret
900367	165	55,75

7556F.2

Briceag pliabil cu lama din inox

- design pliabil
- lungime inchis 10.5 cm
- lungime deschis 16.5 cm
- maner din aluminiu



Cod	L	Pret
900368	165	31,70

7556G

Clește multifuncțional cu 9 operații

- material: inox 420 , maner de aluminiu
- lungime inchis: 12,8 mm
- cleste cu varf lung
- cleste taiat cabluri
- gaura agatare
- surubelnita lata mare
- surubelnita lata mica
- defacator de sticle
- pila
- defacator de conserve
- surubelnita Philip
- perforator
- cutit cu lama zimtata



Cod	L	Pret
900369	165	76,44

7556F.1 Display

Expozitor clește multitoool (24 buc)



Cod	Art.	Nr. piese	Pret
900367D	556F.1 Display	24	1337,95
	7556F.1 (165 mm)		

7556F.2 Display

Expozitor bricege pliabile (48 buc)



Cod	Art.	Nr. piese	Pret
900368D	7556F.2 Display	48	1521,63
	7556F.2 (165 mm)		

900464

Set multitoool, briceag si set de manichiura



Cod	Art.	Nr. piese	Pret
900464	900464	3	122,47
	7556F.1 (165 mm), 7556F.2 (165 mm); 900465		

7556G Display

Expozitor clește multitoool (6 buc)



Cod	Art.	Nr. piese	Pret
900493	7556G Display	6	458,64
	7556G (165 mm)		



husa textila



7556A

Cutter

- maner din plastic
- lama segmentata din otel carbon aliat, cu 13 segmente



Cod	L	B	Pret
621765	160	18	6,45

7556.1 SK4

Set 10 lame de cutter

- material: otel SK4
- set 10 lame cu 13 segmente

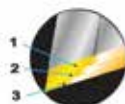

SK4
Design special
Tre muchii de lasere
Cu 50% mai ascutita
Ramane de 3 ori mai mult timp ascutita



Cod	L	A	I	Pret
699766	100	18	5	7,66

7556.1 C60

Set 10 lame de cutter

- material: otel C60
- set 10 lame cu 13 segmente



Cod	L	A	I	Pret
699767	100	18	5	5,17

7556/2AS

Cutter KRONUS 160 mm + Set 10 lame schimb pentru cutter SK4



Cod	L	B	Pret
699770	160	18	14,75

7556/1AS

Cutter KRONUS 160 mm + Set 10 lame schimb pentru cutter C60



Cod	L	B	Pret
699768	160	18	12,07

7556/12AS

Cutter KRONUS 160 mm + Set 10 lame schimb pentru cutter C60+ Set 10 lame schimb pentru cutter SK4



Cod	L	B	Pret
699769	160	18	21,32

7556SS

Cutter cu dubla securitate autoretractabil cu set 10 lame SK5

- securitate maxima, lama se retrage automat in momentul in care nu mai este in contact cu materialul de taiat
- poate fi folosit atat cu mana dreapta cat si cu mana stanga
- schimbare rapida a lamei



Chiar si in situatia in care culisorul este in pozitie de taiere, lama se va retrage automat cand nu mai este in contact cu materialul de taiat.



Comutati butonul in pozitia "change", manevrati culisorul inainte, eliberati lama uzata, montati o lama noua in locas si actionati din nou butonul in pozitia de blocare.

Cod	L	B	Pret
7556SS	160	18	41,96

7556SS.1

Cutter cu dubla securitate autoretractabil in husa PVC

- securitate maxima, lama se retrage automat in momentul in care nu mai este in contact cu materialul de taiat
- poate fi folosit atat cu mana dreapta cat si cu mana stanga
- schimbare rapida a lamei



Comutati butonul in pozitia "change", manevrati culisorul inainte, eliberati lama uzata, montati o lama noua in locas si actionati din nou butonul in pozitia de blocare.

Cod	L	B	Pret
900354	160	18	35,99

7556C

Cutter cu lama retractabila

- material: otel SK5
- maner ABS
- posibilitate de inversare a lamei pentru utilizarea atat cu mana dreapta, cat si cu mana stanga
- lama trapezoidala cu gaura
- gaura de agatare
- arc de retragere al lamei
- sina metalica



Cod	L	A	I	Pret
900401	140	18	30	8,63

7556S

Cutter de securitate autoretractabil

- material: aliaj zinc
- dimensiuni: 167 x 35,5 x 23 mm
- 1 lama otel SK 4; design special
- 3 muchii de taiere; cu 50% mai ascutita fata de lamele C60



Cod	L	B	Pret
7556S	160	18	17,90

7556E

Briceag cutit + cutter cu lama trapezoidală pliabil

- design pliabil
- lungime inchis: 10,5 cm
- greutate: 150g
- cu lama trapezoidală
- mecanism de schimbare rapidă a lamei
- maner din aluminiu și cauciuc
- lama cutit inox 3CR13
- corp scheletic pentru a fi un instrument ușor



Cod	L	B	Pret
7556E			48,21

7605

Surubelnita cu profil lat și maner monomaterial

- lama: oțel crom vanadiu molibden, tratată integral
- lama nichelată
- maner: formă ergonomică
- maner-polipropilenă
- gaură de agățare
- în concordanță cu standardul ISO 2380-1,2



Cod	a	b	D	L	L1	Pret
621767	0,8	4,0	100	185	4	4,56
621768	1,2	6,5	150	250	6	8,78

7615

Surubelnita cu profil Phillips și maner monomaterial

- lama: oțel crom vanadiu molibden, tratată integral
- lama nichelată
- maner: formă ergonomică
- maner-polipropilenă
- gaură de agățare
- în concordanță cu standardul ISO 8764-1,2



Cod	Phillips	D	L	L1	Pret
621771	PH 1	80	165	4,5	4,56
621772	PH 2	100	200	6	7,60

7556.05T

Set 5 lame trapezoidale

- material: oțel SK5
- dimensiune: 61x19x0,6 mm



Cod	L	A	I	Pret
900334	60	19	0,6	3,55

7556.10T

Set 10 lame trapezoidale

- material: oțel SK5
- dimensiune: 61x19x0,6 mm



Cod	L	A	I	Pret
900335	60	19	0,6	6,34

7556.05H

Set 5 lame tip carlig

- material: oțel C60
- dimensiune: 48x19x0,6 mm



Cod	L	A	I	Pret
900336	60	19	0,6	7,47

7556.10C

Set 10 lame trapezoidale

- material: oțel C60
- dimensiune: 61x19x0,6 mm



Cod	L	A	I	Pret
900434	60	19	0,6	5,04

7625

Surubelnita cu profil Pozidrive și maner monomaterial

- lama: oțel crom vanadiu molibden, tratată integral
- lama nichelată
- maner: formă ergonomică
- maner-polipropilenă
- gaură de agățare
- în concordanță cu standardul ISO 8764-1,2

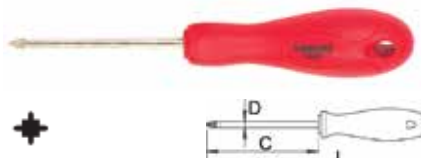

Cod	Pozidrive	D	L	L1	Pret
621769	PZ 1	80	165	4,5	4,56
621770	PZ 2	100	200	6	7,60

7627

Set surubelnita cu maner monomaterial în cutie de carton



Cod	Art.	Nr. piese	Pret
622109	7627	6	39,75
	7615 (PH 1x80, PH 2x100), 7625 (PZ 1x80, PZ 2x100), 7605 (0.8x4.0x100, 1.2x6.5x150)		

7630

Tester de tensiune

- surubelnita detectoare până la 220-250 V
- Standard: EN60900

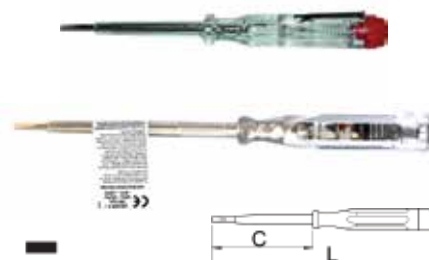

Cod	a	b	C	L	Pret
7630140	0,5	3,0	60	140	6,39
621766	0,6	3,5	90	180	10,34

7628

Set surubelnita cu maner monomaterial și tester de tensiune în cutie de carton



Cod	Art.	Nr. piese	Pret
622110	7628	7	46,39
	7615 (PH 1x80, PH 2x100), 7625 (PZ 1x80, PZ 2x100), 7605 (0.8x4.0x100, 1.2x6.5x150), 7630 (180 mm)		

7627A

Set surubelnita cu maner monomaterial in cutie de carton



Cod	Art.	Dimensiuni	Pret
622109A	7627A	6	39,75
	7615 (PH 1x80, PH 2x100), 7625 (PZ 1x80, PZ 2x100), 7605 (0.8x4.0x100, 1.2x6.5x150)		

7500

Delta lata cu maner bimaterial pentru lemn

- material: crom-vanadiu
- lama forjata, solida, dintr-o bucata asigura integritatea structurala
- ascutite, gata de utilizare
- coada mare, puternica tine manerul bine fixat
- manerul rezistent la spargere ajuta la reducerea vibratiilor
- manerul de prindere moale, antialunecare
- pentru un confort sporit



Cod	l	L	Pret
900355	6	260	25,58
900356	8	260	25,78
900357	12	260	26,16
900358	14	260	26,35
900359	16	260	26,54
900360	20	260	26,94
900361	30	260	28,49

7500S3

Set delta late cu maner bimaterial pentru lemn 8, 12, 20 mm

- material: crom-vanadiu
- lama forjata, solida, dintr-o bucata asigura integritatea structurala
- ascutite, gata de utilizare
- coada mare, puternica tine manerul bine fixat
- manerul rezistent la spargere ajuta la reducerea vibratiilor
- manerul de prindere moale, antialunecare
- pentru un confort sporit



Cod	Art.	Nr. piese	Pret
900479	7500S3	3	77,32
	7500 (8, 12, 20 mm)		

7660A

Delta pentru constructii

- material: OLC 45
- forjata
- capete tratat prin curenti de inalta frecventa
- duritate pe capete: 48 ± 3 HRC
- acoperire: vopsire
- executie conform standardului DIN 7254



Cod	mm	B	L	G	Pret
70978	16	23	250	403	15,27
70980	16	26	350	725	21,13

7670A

Spit pentru constructii

- material: OLC 45
- forjata
- capete tratat prin curenti de inalta frecventa
- duritate pe capete: 48 ± 3 HRC
- acoperire: vopsire
- executie conform standardului DIN 7256



Cod	mm	L	G	Pret
70974	16	300	578	17,94
70975	16	350	696	21,13

7667A

Delta lata pentru zidarie

- material: OLC 45
- forjata
- capete tratat prin curenti de inalta frecventa
- duritate pe capete: 45 ± 3 HRC
- acoperire: vopsire



Cod	mm	B	a	L	Pret
70950	50	23	13	230	31,96
70951	70	23	13	230	33,55

7660HS

Manson de cauciuc pentru dalti de constructii



Cod	Dimensiune	Pret
900333	90 mm	2,23

7667HS

Manson de cauciuc pentru dalti de zidarie



Cod	Dimensiune	Pret
900332	95 mm	4,29

7660AH

Delta cu manson pentru constructii

- material: OLC 45
- forjata
- capete tratat prin curenti de inalta frecventa
- duritate pe capete: 48 ± 3 HRC
- acoperire: vopsire
- executie conform standardului DIN 7254



Cod	mm	B	L	G	Pret
70978H	16	23	250	403	17,50
70980H	16	26	350	725	23,37

7670AH

Spit cu manson pentru constructii

- material: OLC 45
- forjata
- capete tratat prin curenti de inalta frecventa
- duritate pe capete: 48 ± 3 HRC
- acoperire: vopsire
- executie conform standardului DIN 7256



Cod	mm	L	G	Pret
70974H	16	300	578	20,18
70975H	16	350	696	23,37

7667AH

Delta lata cu manson pentru zidarie

- material: OLC 45
- forjata
- capete tratat prin curenti de inalta frecventa
- duritate pe capete: 45 ± 3 HRC
- acoperire: vopsire



Cod	mm	B	a	L	Pret
70950H	50	23	13	230	36,26
70951H	70	23	13	230	37,85

7710

Ruleta

- carcasa din doua materiale
- cu 2 sisteme de blocare si bratară
- banda metrologizata



banda metrologizata conform directivei 2004/22/EC

Cod	m	d	Pret
699902	2	16	7,66
621764	3	16	10,53
699905	5	19	14,17
699908	8	25	27,20
699910	10	25	35,05

70481

Ruleta

- carcasa din ABS cu protectie de cauciuc
- cu 2 sisteme de blocare si bratară
- banda metrologizata
- banda alb mat 0,105 mm
- clasa de precizie II



Cod	m	l	Pret
900480	3	16	10,57

70594

Ruleta

- carcasa din ABS
- banda din fibra de sticla
- banda printata pe ambele parti
- clasa de precizie III



Cod	m	l	Pret
900481	50		47,47

7710W

Metru pliabil din lemn

- metru pliant 2 m din lemn de fag pentru utilizare profesionala
- ecologic - culoare solubila in apa
- finisaj de suprafata multi-strat, strat superior cu acoperire UV
- rezistent la abraziune si exfoliere
- rezistent la intemperii
- nituri ascunse, conexiuni de otel de arc
- capetele segmentelor frezate
- fittinguri din alama
- clasa de precizie: III

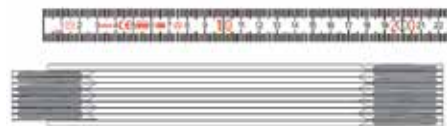

Cod	L1	L	Pret
7710W	2 m	2 m	17,27

7105S

Trusa masurare si taiere "Masuram de doua ori si taiem o singura data!"



Cod	Art.	Nr. piese	Pret
900436	7105S	3	36,30
7710 (2 m); 7710W (2 m); 7556C (140 mm)			

70024

Mininivela Torpedo

- material: plastic
- lungime: 230 mm
- 3 bule
- capete rezistente la impact



Cod	L1	L	Pret
70024	230	230	13,24

70056

Mininivela

- material: plastic
- lungime: 75 mm



Cod	L1	L	Pret
70056	75	75	3,54

71458

Cadru bomfaier pentru metale

- cadru masiv din otel plat 4x19 mm
- combinatie perfecta, impreuna cu panza de fierastrau, pentru taierea otelului, a neferoaselor si a plasticului
- posibilitatea montarii tuturor sortimentelor de panze si de orice latime
- lungime panza 300 mm
- lungime totala 510 mm



Cod	L1	L	Pret
71458	300	510	34,49

71456

Cadru bomfaier cu profil rectangular

- cadru rectangular din otel, maner din aluminiu
- combinatie perfecta, impreuna cu panza de fierastrau, pentru taierea otelului, a neferoaselor si a plasticului
- posibilitatea montarii tuturor tipurilor de panze si de orice latime, la 0° si 90°
- lungime panza 300 mm
- lungime totala 400 mm



Cod	L1	L	Pret
71456	300	450	37,84

71457

Cadru bomfaier cu profil tubular

- cadru tubular din otel, maner din aluminiu
- combinatie perfecta, impreuna cu panza de fierastrau, pentru taierea otelului, a neferoaselor si a plasticului
- posibilitatea montarii tuturor sortimentelor de panze in diferite unghiuri
- lungime panza 300 mm
- lungime totala 400 mm



Cod	L1	L	Pret
71457	300	450	33,37

7753P

Fierastrau de mana Junior

- maner de plastic
- lama interschimbabila

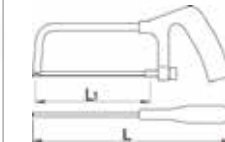

Cod	L1	L	Pret
621778	150	260	32,78

7753P.1

Rezerva fierastrau de mana Junior

- set 10 rezerve



Cod	L1	L	Pret
7753P.1	150	150	33,43

7751.1 / 7751.1/5

Rezerva bomfaier

- material: HCS
- dimensiune 300x13x0,65 mm
- pasul dintilor: 24 TPI
- 7751.1 - livrare vrac, 7751.1/5 livrare 5 bucati cu blister carton

Cod	Dimensiune	Ambalare	Pret
900591	300x13x0,65 mm	vrac	2,45
900594	300x13x0,65 mm	5 bucati/blister	16,90

7812A

Ciocan lacatuserie

- material: otel carbon
- partea de lovire si varful tratate prin inductie
- maner cauciucat

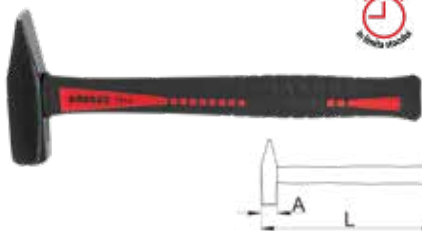

Cod	G	L	Pret
621776	500	320	36,61

7812

Ciocan lacatuserie

- material: OLC 45
- forjat
- partea de lovire si varful tratate
- duritate pe capete: 45 ± 3 HRC
- acoperire: vopsite
- maner din lemn de frasin cu pana ovala speciala
- in concordanta cu standard DIN 1041



Cod	gr	A	L	G	Pret
71431	100	13 x 13	260	145	12,60
71432	200	17 x 17	280	280	15,27
71433	300	20 x 20	300	380	19,88
71434	400	22 x 22	310	487	23,44
71435	500	25 x 25	320	625	25,37
71440	1000	33 x 33	360	1150	42,43
71446	1500	37 x 37	380	1690	56,63
71449	2000	41 x 41	400	2195	70,85

7812F

Ciocan de lacatuserie cu coada din fibra

- material: OLC 45
- forjat
- partile de lovire tratata prin inductie
- acoperire: vopsite
- maner din fibra de sticla
- in conformitate cu standardul DIN 1041



Cod	gr	A	L	G	Pret
900482	500	25 x 25	320	625	48,44

7817

Baros

- material: OLC 45
- forjat
- partile de lovire tratata prin inductie
- duritate pe capete: 48 ± 3 HRC
- acoperire: vopsite
- maner din lemn de frasin cu pana ovala speciala
- in conformitate cu standardul DIN 6475

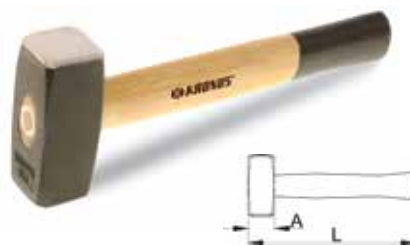

Cod	gr	A	L	G	Pret
71476	1000	36 x 36	260	1070	43,85

7805

Ciocan dulgher

- material: fier
- turnat
- netratat
- acoperire: vopsite
- maner din lemn de frasin cu pana ovala speciala



Cod	gr	L	G	Pret	
71473	300	400	380	21,49	
71479	300	cu magnet	400	390	25,21

7805A

Ciocan dulgher

- material: OLC 45
- forjat
- partea de lovire si varful tratate
- duritate pe capete: 48 ± 3 HRC
- acoperire: vopsite
- maner din lemn de frasin cu pana ovala speciala



Cod	gr	L	G	Pret
71483	300	400	380	30,90

7820/2

Ciocan de cauciuc

- material: cauciuc negru
- maner din lemn



Cod	Dimensiune	Pret
71495	360 g	16,41
71496	450 g	19,58
71497	625 g	24,80

770

Preducele

- pentru perforare: cauciuc, tabla, piele
- material OLC 45
- canal de extractie
- duritate pe capete: 48 - 58 HRC



Cod	Ø	Pret
900437	2	1,77
900438	3	1,77
900439	4	1,96
900440	5	2,39
900441	6	2,81
900442	7	3,18
900443	8	3,80
900444	9	4,42
900445	10	5,17
900446	11	5,79
900447	12	7,21
900448	13	7,78
900449	14	8,80
900450	15	9,84
900451	16	11,59
900452	17	13,50
900453	18	14,88
900454	19	17,54
900455	20	19,10
900456	22	22,02
900457	25	29,86
900458	30	55,33

7770S9

Set preducele 2.5 10 mm / 9 piese

- pentru perforare: cauciuc, tabla, piele
- material OLC 45
- canal de extractie
- duritate pe capete: 48 - 58 HRC
- dimensiuni in set: 2.5/3/4/5/6/7/8/9/10 mm



Cod	Art.	Nr. piese	Pret
900483	7770S9	9	26,75
	770 (2.5, 3, 4, 5, 6, 7, 8, 9, 10 mm)		

70227

Secure

- material: OLC 45
- forjat
- partile de lovire tratata prin inductie
- duritate pe capete: 48 ± 3 HRC
- acoperire: vopsite
- maner din plastic



Cod	gr	L	Pret
70227	1500	800	123,90

71312

Topor

- material: OLC 45
- forjat
- partile de lovire tratata prin inductie
- duritate pe capete: 48 ± 3 HRC
- acoperire: vopsite
- maner din lemn dur, lacuit
- manson din cauciuc pentru protectie lama



Cod	gr	L	Pret
70222	300	360	39,59
70224	500	360	43,68
70226	700	360	46,70

74000

Tarnacop

- material: 65MN
- forjat
- partile de lovire tratata prin inductie
- acoperire: vopsite
- fara maner



Cod	kg	Pret
74000	1,5	55,23

74005

Tarnacop

- material: 65MN
- forjat
- partile de lovire tratata prin inductie 30 HRC
- acoperire: vopsite
- fara maner



Cod	kg	Pret
7405002500	2,5	71,56
7405002000	2,0	62,69

7300C

Levier pentru dulgher

- material otel carbon pentru scule 45
- tratament pe capete cu curenti de inalta frecventa
- duritate pe capete: 45 ± 3 HRC
- acoperire: vopsire



Cod	mm	L	G	Pret
71451	18	500	1180	28,06
71452	18	600	1385	31,78
71453	18	700	2190	35,87

73000900

Levier pentru dulgher

- material otel carbon pentru scule 45
- tratament pe capete cu curenti de inalta frecventa
- duritate pe capete: 45 ± 3 HRC
- acoperire: vopsire



Cod	mm	L	G	Pret
73000900	30 x 16	900	2715	102,10

7146

Scula pentru indoit fier beton

- material: OLC 45
- forjata
- acoperire: vopsire
- duritate: 36-42 HRC



Cod	mm	Ø	L	Pret
71466	6 x 8	10	300	26,45
71467	10 x 12	12	400	44,15
71469	14 x 16	14	500	59,01

7150R

Mistrie rotunjita

- material: OLC 50
- grosime: 0,7 mm
- duritate 52 HRC
- maner lemn



Cod	Dimensiune	Pret
71560	180 mm	14,17
71561	200 mm	15,10
71562	210 mm	15,47

7150P

Mistrie patrata

- material: OLC 50
- grosime: 0,7 mm
- duritate 52 HRC
- maner lemn



Cod	Dimensiune	Pret
71571	180 mm	14,17
71572	200 mm	15,10

7150T

Mistrie triunghiulara

- material: OLC 50
- grosime: 0,7 mm
- duritate 52 HRC
- maner lemn



Cod	Dimensiune	Pret
71578	140 mm	8,75
71579	160 mm	9,33

7011

Gletiera cu maner de lemn

- material: 3cr13
- grosime: 0,7 mm
- maner lemn



Cod	Dimensiune	Pret
70111	200 x 80 mm	32,44
70110	240 x 100 mm	34,49
70112	130 x 280 mm	38,78

7722SQ

Menghina de banc cu baza rotativa

- baza rotativa cu suruburi de fixare
- acoperire: vopsite
- falci striate, tratate
- ax si maner din otel forjat

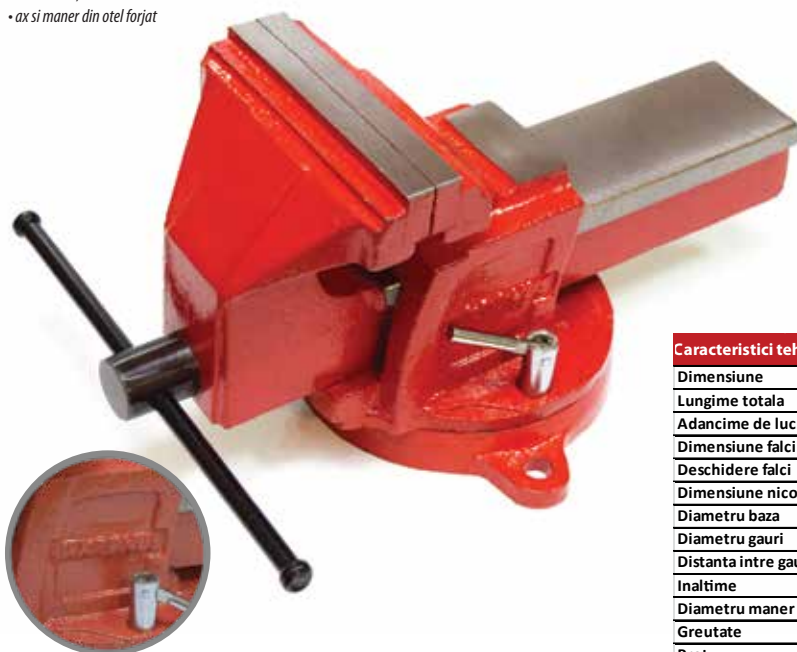

ATENȚIE! Nicovala se utilizeaza numai pentru lucrari de finete

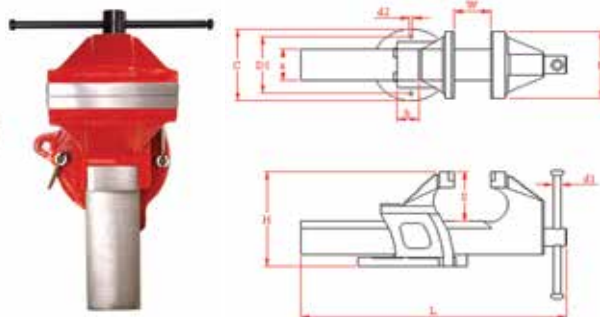

Caracteristici tehnice			M16-80	M16-100	M16-125	M16-150	M16-200	M16-250
Dimensiune		mm	80	100	125	150	200	250
Lungime totala	L	mm	235	275	350	390	470	565
Adancime de lucru	S	mm	50	55	72	90	90	116
Dimensiune falci	B	mm	80	100	125	150	200	250
Deschidere falci	W	mm	80	100	125	150	200	250
Dimensiune nicovala	axb	mm	38x25	40x28	56x26	70x38	75x48	98x75
Diametru baza	C	mm	103	112	140	165	170	190
Diametru gauri	d2	mm	10	10	11	12	12	13
Distanta intre gauri	D1	mm	95	96	125	146	147	285
Inaltime	H	mm	106	111	145	173	180	240
Diametru maner	d1	mm	8	8	10	10	10	14
Greutate		kg	3,80	4,80	8,40	11,60	18,00	37,00
Pret			203,79	247,98	349,04	467,50	673,09	1098,21

7722

Menghina de banc

- realizata din fonta de inalta calitate
- falci forjate din otel carbon, interschimbabile
- acoperire: vopsire
- operare usoara

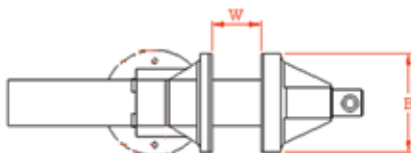

7722.1

Baza rotativa pentru menghina 7722

- corpul din otel turnat
- materialul altor parti: otel special de scule
- baza menghinei poate fi rotita cu 360°



Cod	Dimensiune	Pret
900508	80 mm	81,97
900509	100 mm	85,26
900510	125 mm	102,71
900511	150 mm	108,52
900512	200 mm	116,27

Caracteristici tehnice	U.M.	900503	900504	900505	900506	900507
Dimensiune	Mm	80	100	125	150	200
Greutate neta	KG	5,9	9,5	13,9	22	29
Dimensiune falca	Mm	80	100	120	150	200
Deschidere maxima	Mm	80	100	125	150	200
Pret		243,38	347,84	472,24	672,22	916,72

71023**Centura din piele pentru scule**

- material: piele bovina
- 2 buzunare mari pentru cuie
- 6 buzunare mici pentru scule
- 2 agatatori din piele pentru ciocane
- 1 agatatoare metalica pentru ruleta
- capse pentru rezistenta sporita



Cod	Tip	Pret
71023	centura scule cu 2 buzunare	29,48

71024**Centura din piele pentru scule**

- material: piele bovina
- 4 buzunare mari pentru cuie
- 6 buzunare mici pentru scule
- 2 agatatori din piele pentru ciocane
- 1 agatatoare metalica pentru ruleta
- 1 buzunar tip teaca
- capse pentru rezistenta sporita



Cod	Tip	Pret
71024	centura scule cu 11 buzunare	45,47

900462**Suport din piele cu doua buzunare pentru dulgher**

- material: piele bovina
- centura textila
- capse pentru rezistenta sporita



Cod	Tip	Pret
900462		23,08

900459**Suport din piele pentru ruleta**

- material: piele bovina
- capse pentru rezistenta sporita



Cod	Pret
900459	15,78

900460**Suport din piele cu carlig pivotant pentru ciocan**

- material: piele bovina
- inel metalic nichelat



Cod	Pret
900460	10,85

900461**Suport din piele cu carlig fix pentru ciocan**

- material: piele bovina
- inel metalic nichelat



Cod	Pret
900461	9,67

900463**Suport textil cu 12 buzunare pentru scule**

- material: textil



Cod	Pret
900463	11,83

7914/5**Cutie scule cu 5 compartimente**

- pentru ateliere mecanice si solutie pentru depozitarea sculelor
- 5 compartimente
- 7 zone de depozitare
- grosime tabla 0,4 mm
- vopsita in doua culori
- usor de deschis si inchis
- maner dublu pentru mai mult confort
- dimensiuni: 450x200x200 mm
- greutate: 3,1 kg



Cod	mm	grosime	Pret
701985	450x200x200	0,4	159,72

TRUSA CASEI**Trusa casei 13 piese**

Cod	Art.	Dimensiuni	Pret
690173	-	13	171,28
7441	(240 mm), 7615 (PH 1x80), 7605 (0.8x4.0x100), 7630 (180 mm), 7710 (3 m), 7125/2 (8, 10, 13, 17, 19), 7812A (500 g), 7556A (160 mm), 7556.1 SK4 (100 mm)		

7909/10 TSO1**Trusa scule OPTIM 14 piese**

Cod	Art.	Dimensiuni	Pret
TSO1	7909/10	14	371,61
7462 (160 mm), 7408 (180 mm), 7615 (PH 1x80, PH 2x100), 7625 (PZ 1x80, PZ 2x100), 7605 (0.8x4.0x100, 1.2x6.5x150), 7630 (180 mm), 7710 (3 m), 7812 (500 g), 7441 (240 mm), 7250 (250 mm), 7556A (160 mm), 7909/10			

7909/10 TSO2**Trusa scule OPTIM 21 piese**

Cod	Art.	Dimensiuni	Pret
TSO2	7909/10	21	461,42
7462 (160 mm), 7408 (180 mm), 7615 (PH 1x80, PH 2x100), 7625 (PZ 1x80, PZ 2x100), 7605 (0.8x4.0x100, 1.2x6.5x150), 7630 (180 mm), 7710 (3 m), 7125/2 (8, 10, 12, 13, 14, 17, 19, 22), 7812 (500 g), 7441 (240 mm), 7556A (160 mm), 7909/10			

7914/5ak1

Trusa scule mecanici auto 133 piese, in cutie metalica



Cod	Art.	Dimensiuni	Pret
900514	7914/5ak1	133	1423,27
7110 CT	(6x7, 8x9, 10x11, 12x13, 14x15, 16x17, 18x19, 20x22, 21x23, 24x26, 25x28, 27x32) cu husa textila		
7180 CT	(6x7, 8x9, 10x11, 12x13, 14x15, 16x17, 18x19, 20x22) cu husa textila		
7190-1/2"	(10, 11, 12, 13, 14, 15, 16, 17, 18, 19, 20, 21, 22, 23, 24, 27, 30, 32)		
	7190.3-1/2" (250 mm)		
	7190.5-1/2" (250 mm)		
	7190.6-1/2" (75 mm)		
	7190.1-1/2" (260 mm)		
	7408 BI (160 mm)		
	7441 (240 mm)		
	7462 BI (160 mm)		
	7605 (0.8x4.0x100, 1.2x6.5x150)		
	7615 (PH 1x80, PH 2x100)		
	7812 (500 mm)		
	7192HX-1/2" (HX4, HX5, HX6, HX8, HX10, HX12)		
	7192TX-1/2" (TX20, TX25, TX30, TX40, TX45, TX50)		
	7191E-1/2" (E10, E12, E14, E16, E18, E20, E22, E24)		
	72879PH TIS (TX10, TX15, TX20, TX25, TX27, TX30, TX45)		
	72883PH SL (1.5, 2, 2.5, 3, 4, 5, 6, 8, 10 mm)		
	7187TX-1/4" (TX8, TX10, TX15, TX20, TX25, TX27, TX30, TX40)		
	7187SL-1/4" (0.8x4.0, 1.0x5.5, 1.2x7.0 mm)		
	7192SL-1/2" (1.2x8.0, 1.6x10.0, 2.0x12.0 mm)		
	7187PH-1/4" (PH1, PH2)		
	7192PH-1/2" (PH2, PH3)		
	7187HX-1/4" (HX3, HX4, HX5, HX6, HX7)		
	7189E-1/4" (E4, E5, E6, E7, E8, E10)		
	7188/2-1/4" (4, 5, 6, 7, 8, 9, 10, 11, 12, 13, 14 mm)		
	7188.3-1/4" (120 mm)		
	7188.4-1/4" (150 mm)		
	7188.5-1/4" (50 mm)		
	7188.1-1/4" (152 mm)		
	7914/5 (450x200x200 mm)		

7914/5ak2

Trusa scule instalatori 158 piese, in cutie metalica



Cod	Art.	Dimensiuni	Pret
900515	7914/5ak2	158	964,80
7112/2	(6x7, 8x9, 10x11, 12x13, 14x15, 16x17, 18x19, 20x22, 21x23, 24x26, 25x28, 27x32, 36x41)		
7605	(0.8x4.0x100; 1.2x6.5x150)		
7408 BI	(180 mm)		
7615	(PH1x80; PH2x100)		
7625	(PZ1x80; PZ2x100)		
7660A	(16x250 mm)		
7670A	(16x300 mm)		
6776A	(50, 70 mm)		
72883	(1.5, 2, 2.5, 3, 4, 5, 6, 8, 10 mm)		
701507	(100 piese)		
701791	(7, 8, 10, 13)		
7441	(240 mm)		
7482	(1.1/2")		
7531	(224 mm)		
7812	(500, 1000 g)		
7710	(5 m)		
7556/1AS	(160 mm)		
71456	(300 mm)		
R-3013-24-P	(300x13x0.65 24 TPI) (x10 bucati)		
70024	(230 mm)		
70056	(75 mm)		
7914/5	(450x200x200 mm)		



Cap tubular scurt 1/4", magnetic

• material: crom-vanadiu

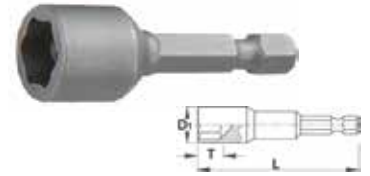

Cod	mm	Pret
701404	7	5,28
701406	8	5,28
701433	10	5,66
701416	13	7,22

Cap tubular lung 1/4", magnetic

• material: crom-vanadiu

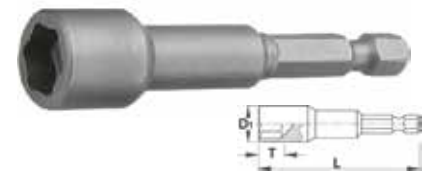

Cod	mm	Pret
701428	7	6,26
701430	8	6,26
701432	10	6,45
701439	13	7,82

701791

Set capete tubulare 7 / 8 / 10 / 13 mm 1/4" - 38 mm

• componenta set: 7, 8, 10, 13, mm
• material tija: otel crom vanadiu



Cod	Componenta	Pret
701791	7 / 8 / 10 / 13 mm	12,71

701663

Set biti 31 piese

• PH1, 3xPH2, PH3
• PZ1, 3xPZ2, PZ3
• T10, T15, 3xT20, 3xT25, T27, 2xT40
• HX3, HX4, HX5, HX6
• SL4.5, SL4.5, SL6.5
• adaptor magnetic 60 mm
• material: S2



Cod	Componenta	Pret
701663	31 piese	53,29

701507

Set 100 biti si accesorii 1/4"

- PH 0x25, PH 1x25, 5 x PH 2x25, PH 3x25
- PZ 0x25, PZ 1x25, 5 x PZ 2x25, PZ 3x25
- SQ 0x25, SQ 1x25, SQ 2x25, SQ 3x25
- TX 8, 10, 15, 20, 25, 27, 30, 40, 45
- Clutch 1, 2, 3
- (2x) HX 1.5, 2, 2.5, 3, 4, 5, 5.5, 6, 8
- SL 3, 4, 4.5, 5, 5.5, 6, 6.5, 7, 8
- TRI-WING® 1, 2, 3, 4
- XZN MS, M6, M8
- TORQ-SET® 6, 8, 10
- Spanner #0, 1, 2, 3
- TORX® cu gaura TX 8, 10, 15, 20, 25, 27, 30, 40, 45
- HEX cu gaura (2x) HX 2, 2.5, 3, 4, 5, 6
- TRI-WING® 1, 2, 3, 4
- Adaptor 1/4 - 1/4"
- Adaptor 1/4"-C6.3
- Adaptor tip "Y"
- Adaptor magnetic 1/4"
- Prelungitor 1/4" 50 mm



Cod	Dimensiuni	Pret
701507	100 piese	106,65

76515E6,3

Bit lung cu profil hexagonal



Cod	Dimensiune	Lungime	Amb	Pret
70108701	HX 3	50	vrac	2,11
70108801	HX 4	50	vrac	2,11
70108901	HX 5	50	vrac	2,11
70109001	HX 6	50	vrac	2,11
900548	HX 3	50	3	7,40
900549	HX 4	50	3	7,40
900550	HX 5	50	3	7,40
900551	HX 6	50	3	7,40
70108705	HX 3	50	5	13,21
70108805	HX 4	50	5	13,21
70108905	HX 5	50	5	13,21
70109005	HX 6	50	5	13,21
70108710	HX 3	50	10	26,42
70108810	HX 4	50	10	26,42
70108910	HX 5	50	10	26,42
70109010	HX 6	50	10	26,42

73513A

Mandrina cu cheie 13mm 1/2"-20UNF

- capacitate mandrina: -1,5-13,0 mm
- prindere pe filet: 1/2"-20 UNF
- lungime fara bacuri: 59,0 mm
- lungime totala: 71,5 mm
- diametru mandrina: 52 mm
- oțel calit
- elemente active rectificcate



Dom adaptor SDS PLUS 1/2"-20UNF



Cheie pentru mandrina

Cod	Dimensiune	Pret
73513A	13mm 1/2"-20UNF	31,99

Panza circulara placata CMS pentru lemn



Cod	D	b	B	d	Z	Pret
900337	170	1.4	2.4	20	20	
900338	170	1.4	2.4	20	30	
900339	300	2	3.0	30	96	
900340	160	1.4	2.4	20	40	
900341	210	1.4	2.4	30	60	
900342	315	2	3.0	30	96	
900343	160	1.4	2.4	20	20	
900344	190	1.4	2.4	30	24	
900345	210	1.4	2.4	30	24	
900346	230	1.6	2.6	30	24	
900347	250	1.8	2.8	30	30	
900348	160	1.4	2.4	20	30	
900349	180	1.4	2.4	30	40	
900350	184	1.4	2.4	20	40	
900351	180	1.4	2.4	30	24	
900352	230	1.6	2.6	30	40	
900353	190	1.4	2.4	30	40	

900465

Set manichiura

- Material: din otel inoxidabil
- Dimensiuni: 10,5 cm x 8 cm
- Etui din piele ecologica

- unghiera mare
- unghiera medie
- unghiera mica
- forfecuta
- pila unghii
- impingator / cutit cuticule
- penseta
- cutit cuticule
- curatitor urechi



Cod	Pret
900465	27,16

900491

Cleste pentru spart nuci

- material: aliaj de zinc, cromat
- greutate 90 g



Cod	g	Pret
900490	vrac	90 14,15
900491	blister	90 15,89

7914/5

Cutie scule cu 5 compartimente

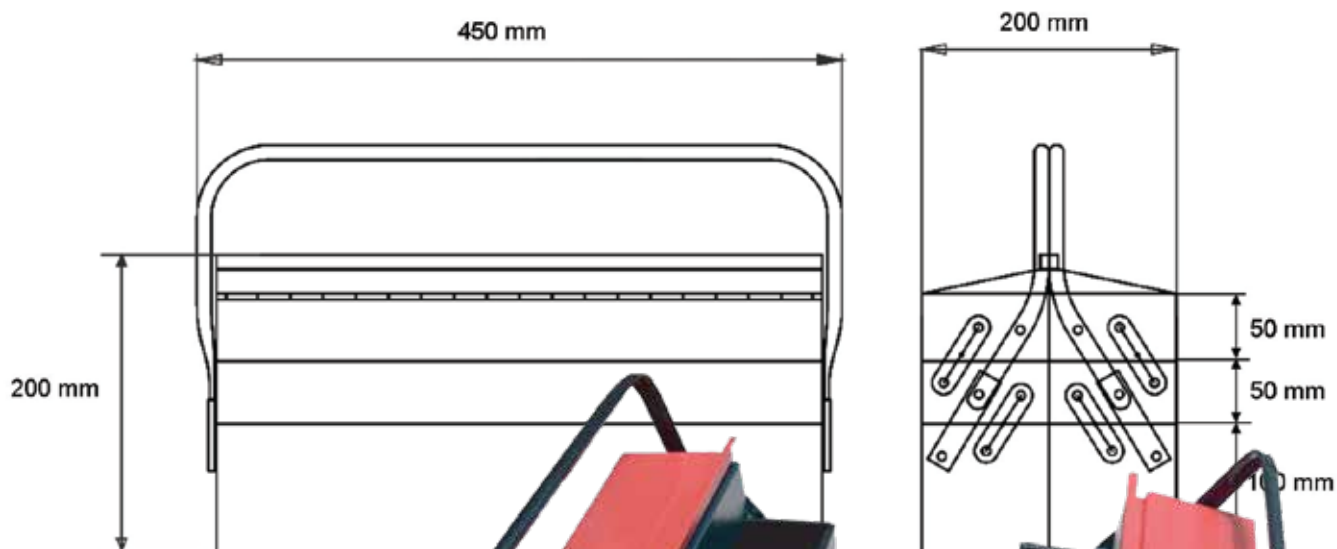

- pentru ateliere mecanice si solutie pentru depozitarea sculelor
- 5 compartimente
- 7 zone de depozitare
- grosime tabla 0,4 mm
- vopsita in doua culori
- usor de deschis si inchis
- maner dublu pentru mai mult confort
- dimensiuni: 450x200x200 mm
- greutate: 3,1 kg



Cod	mm	grosime	Pret
701985	450x200x200	0,4	159,72

KRONUS®
Professional Quality