



www.port-bag.com



PORT-BAG® / PLASTİK TAKIM ÇANTALARI / PLASTIC TOOL BOXES

İŞIK KALIP SANAYİ ve TİC. LTD. ŞTİ.

1972 yılında kurulan firmamız, 1990 yılından bugüne plastik alet çantaları ve stoklama elemanları imalatı ve ihracatı üzerine dünya pazarında ülkemizi temsil etmektedir.

Her geçen gün kendi tasarımlarımız olan ürünlerimizi çeşitlendirip geliştirirken, hizmet ve ürün kalitemizi ISO-9001 ile belgelendirdik. PORT-BAG markasını ve kalitesini, siz değerli müşterilerimizin desteği ile dünya pazarında kabul ettirmenin haklı gururunu yaşıyoruz.

10.000 m² alanda kurulu fabrikamızda, kendi kalıphanemiz, son teknolojiye sahip üretim makineleri, dünya standardındaki darbe mukavemeti yüksek hammadde ile profesyonel bir kadronun eşliğinde imal edilen ürünlerimiz Avrupa, Güney Amerika, Avustralya ve Orta Doğu ülkelerine ihraç edilmektedir.

Gelişimin, kalitenin ve hizmetin sınırı olmadığına inanan firmamız, koşulsuz müşteri memnuniyeti felsefesi ile siz değerli müşterilerimize hizmete devam edecektir. Daha fazla bilgi için lütfen bizi arayınız.

Our company which was established in 1972, is the manufacturer and exporter of plastic tool boxes and plastic storage equipments since 1990.

We have certified our products and service quality with ISO 9001-2000. We are increasing and improving our product range day by day and proud to carry our PORT-BAG brand to the whole world with our valuable customer supports.

Our products are produced with the last technology machines by our professional team. We have our own mould shop in our 10.000 square meter producing plant.

Today we are exporting our products to all European countries, South and Middle America, Australia, Africa and Middle East countries.

Our aim is improving our quality and service while enlarging our product range.

We are here to serve you. For any further information and questions, please do not hesitate to contact us.

SATIŞ NOKTALARI / SALES POINTS



İÇİNDEKİLER / INDEX

DUVAR PANEL SETİ / WALL PANEL SET	04-05
PLASİK TAKIM ÇANTALARI / PLASTIC TOOL BOXES	
COMPACTO SERİSİ / COMPACTO SERIES	06-08
COMBO SERİSİ / COMBO SERIES	09-11
STRONGO SERİSİ / STRONGO SERIES	12-18
META SERİSİ / META SERIES	19-22
EKONO SERİSİ / EKONO SERIES	23-27
MAESTRO SERİSİ / MAESTRO SERIES	28-33
BASIC SERİSİ / BASIC SERIES	34-36
RAFLI SERİSİ / CANTILEVER SERIES	37-39
MOBİL SERİSİ / MOBİL SERIES	40-42
EL ALETLERİ ÇANTALARI / POWER TOOL BOXES	43-49
AVADANLIKLAR / STORAGE BINS	50-54
PLASTİK ÇEKMECE SETLERİ / PLASTIC CABINETS	55-63
ORGANİZERLER / ORGANIZERS	64-70
MODÜLER GRUPLAR / MODULAR GROUPS	71-86
ÜRÜN BİLGİLERİ / PRODUCT DATA	89-96

DUVAR PANEL SETİ / WALL PANEL SET



Kod No **DP.01**
Art. Code

EAN / 8691311930104



Duvar Paneli / Wall Panel
420 x 590 x 20 mm
2 Adet / Pcs.



Küçük Kutu / Small Box
115 x 100 x 74 mm
16 Adet / Pcs.



Orta Kutu / Medium Box
165 x 100 x 74 mm
8 Adet / Pcs.

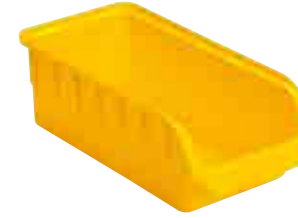

Büyük Kutu / Large Box
210 x 100 x 74 mm
4 Adet / Pcs.



Askı Parçası / Hook
50 x 10 x 20 mm
10 Adet / Pcs.

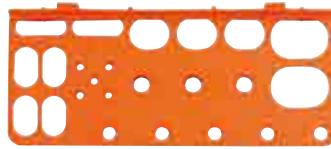

Alet Tutucu / Tool Holder
210 x 95 x 43 mm
1 Adet / Pcs.



Matkap/ Tornavida Ucu Tutucu
Drill and bit holder
165 x 50 x 27 mm
1 Adet/ Pcs.



İki ağızlı ve yıldız anahtar tutucu
Ring and open-ended spanner holder
215 x 65 x 28 mm
1 Çift / Pair

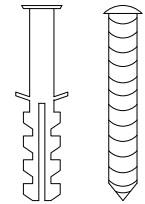

Vida & Dübel Seti
Screw & Wall plugs
20 Adet/ Pcs.



1 Adet / Pcs

COMPACTO SERISI / COMPACTO SERIES



16"

COMPACTO
COMPACTO

Kod No
Art. Code **CP.01**

EAN / 8691311920167

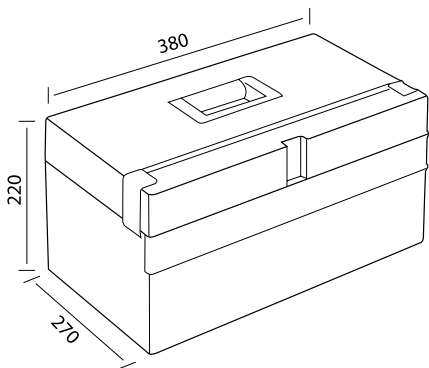

20"

COMPACTO
COMPACTO

Kod No **CP.02**
Art. Code

EAN / 8691311920204

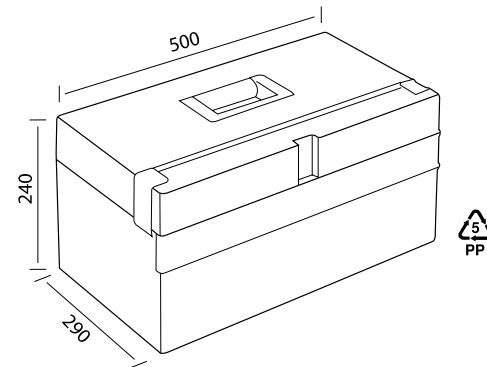



18"

COMBO
COMBO

Kod No **CM.01**
Art. Code
EAN / 8691311960187



Metal Gövde / Metal Body

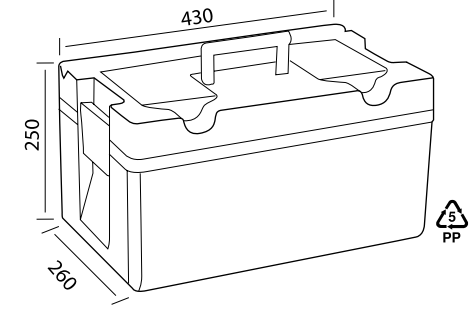

2 Adet /
Pcs



22"

COMBO
COMBO

Kod No **CM.02**
Art. Code
EAN / 8691311960217



Metal Gövde / Metal Body

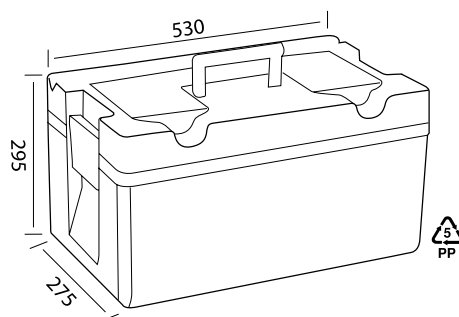

STRONGO SERİSİ / STRONGO SERIES



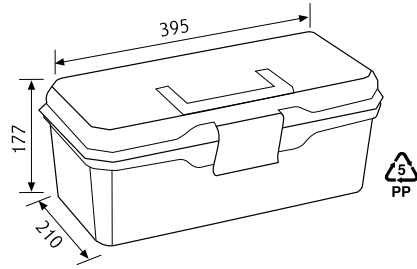

16"

ORGANİZERLİ STRONGO
STRONGO WITH ORGANIZER

Kod No **S.P.01**
Art. Code

EAN / 8691311950164

Sap dikey pozisyonda iken gövde ve kapağı kilitleyerek, kilitler açık bile olsa çantanın açılmasını önler

While the handle is in vertical position, handle locks the body to the lid and avoids opening even if the main latches are opened



18"

ORGANİZERLİ STRONGO

STRONGO WITH ORGANIZER

Kod No **S.P.02**
Art. Code

EAN / 8691311950188



Sap dikey pozisyonda iken gövde ve kapağı kilitleyerek, kilitler açık bile olsa çantanın açılmasını önler

While the handle is in vertical position, handle locks the body to the lid and avoids opening even if the main latches are opened

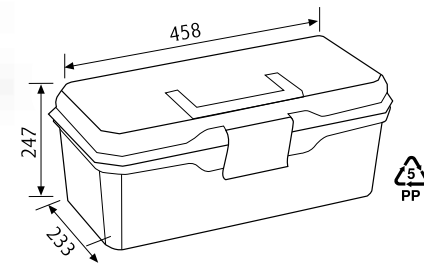

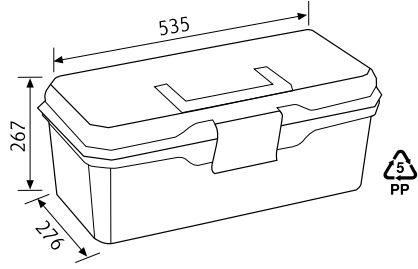

21"

ORGANİZERLİ STRONGO
STRONGO WITH ORGANIZER

Kod No
Art. Code **S.P.03**

EAN / 8691311950218

Sap dikey pozisyonda iken gövde ve kapağı kilitleyerek, kilitler açık bile olsa çantanın açılmasını önler

While the handle is in vertical position, handle locks the body to the lid and avoids opening even if the main latches are opened



16"

ORGANİZERLİ STRONGO METAL
STRONGO METAL WITH ORGANIZER

Kod No **S.M.01**
Art. Code

EAN / 8691311951161

Sap dikey pozisyonda iken gövde ve kapağı kilitleyerek, kilitler açık bile olsa çantanın açılmasını önler

While the handle is in vertical position, handle locks the body to the lid and avoids opening even if the main latches are opened

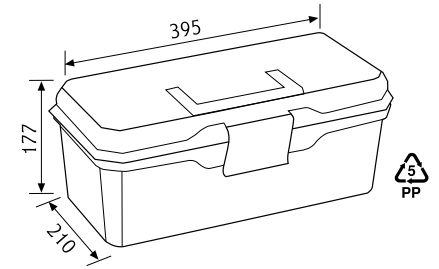

18"

ORGANİZERLİ STRONGO METAL

STRONGO METAL WITH ORGANIZER

Kod No
Art. Code **S.M.02**

EAN / 8691311951185

Sap dikey pozisyonda iken gövde ve kapağı kilitleyerek, kilitler açık bile olsa çantanın açılmasını önler

While the handle is in vertical position, handle locks the body to the lid and avoids opening even if the main latches are opened

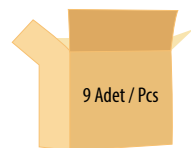
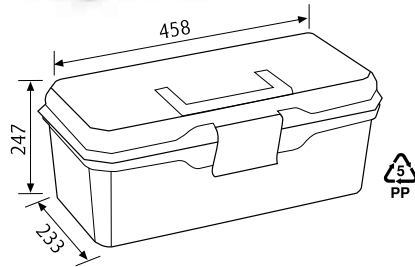

21"

ORGANİZERLİ STRONGO METAL
STRONGO METAL WITH ORGANIZER

Kod No **S.M.03**
Art. Code
EAN / 8691311951215

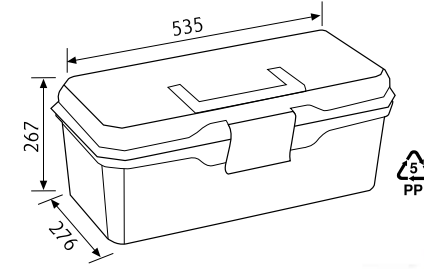

Sap dikey pozisyonda iken gövde ve kapağı kilitleyerek, kilitler açık bile olsa çantanın açılmasını önler

While the handle is in vertical position, handle locks the body to the lid and avoids opening even if the main latches are opened



PLASTİK TAKIM ÇANTALARI / PLASTIC TOOL BOXES



PORT-BAG®

META SERİSİ / META SERIES



19"

ORGANİZERLİ META
META WITH ORGANIZER

Kod No **M.L.03**
Art. Code
EAN / 8691311904839

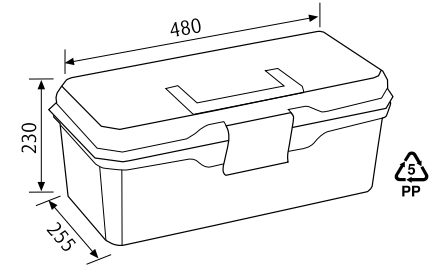

METAL KİLİT / METAL LOCK



MATKAP UCU TUTUCU / DRILL HOLDER



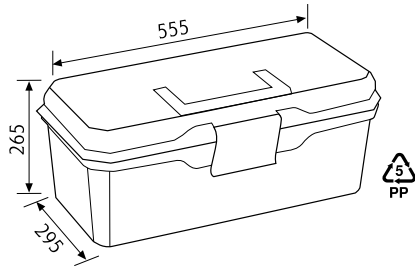

22"

ORGANİZERLİ META
META WITH ORGANIZER

Kod No
Art. Code **M.L.04**

EAN / 8691311902514



METAL KİLİT / METAL LOCK

MATKAP UCU TUTUCU / DRILL HOLDER



26"

ORGANİZERLİ META
META WITH ORGANIZER

Kod No
Art. Code **M.L.05**
EAN / 8691311905515

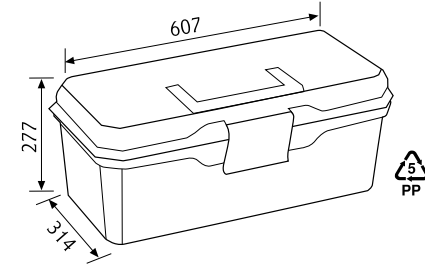

METAL KİLİT / METAL LOCK





Nakliye' de
% 50' ye Varan Hacim Tasarrufu
% 50 Savings in Freight Costs

EKONO SERİSİ / EKONO SERIES



13"

ORGANİZERLİ EKONO
EKONO WITH ORGANIZER

Kod No
Art. Code **P.E.01**

EAN / 8691311083473

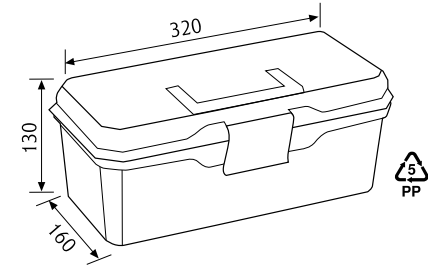

16"

ORGANİZERLİ EKONO
EKONO WITH ORGANIZER

Kod No P.E.02
Art. Code

EAN / 8691311092390

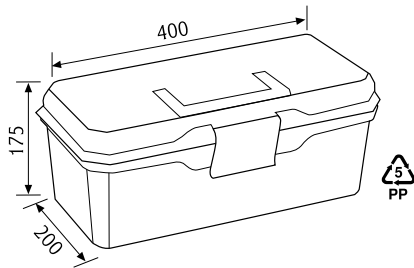

19"

ORGANİZERLİ EKONO
EKONO WITH ORGANIZER

Kod No **P.E.03**
Art. Code

EAN / 8691311093748

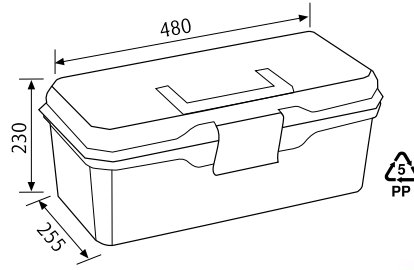

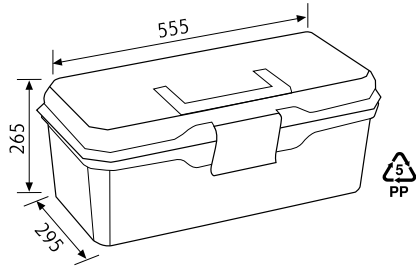

22"

ORGANİZERLİ EKONO
EKONO WITH ORGANIZER

Kod No **P.E.04**
Art. Code

EAN / 8691311092130



MAESTRO SERISI / MAESTRO SERIES



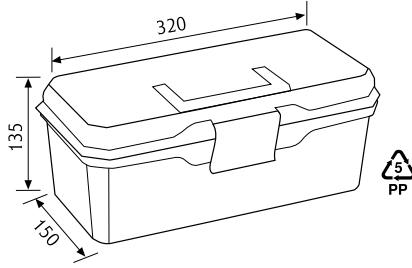

13"

ORGANİZERLİ MAESTRO
MAESTRO WITH ORGANIZER

Kod No P.0.06
Art. Code

EAN / 8691311494941



16"

ORGANİZERLİ MAESTRO
MAESTRO WITH ORGANIZER

Kod No **P.0.07**
Art. Code

EAN / 8691311487639

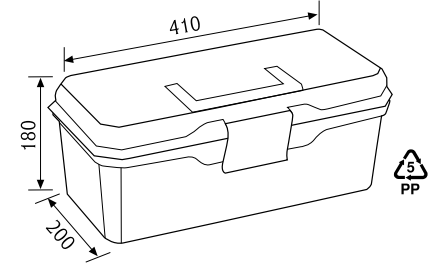

12 Adet / Pcs

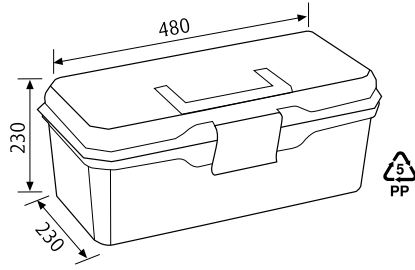

19"

ORGANİZERLİ MAESTRO
MAESTRO WITH ORGANIZER

Kod No
Art. Code **P.0.05**

EAN / 8691311493029



22"

ORGANİZERLİ MAESTRO
MAESTRO WITH ORGANIZER

Kod No **P.0.08**
Art. Code

EAN / 8691311352050

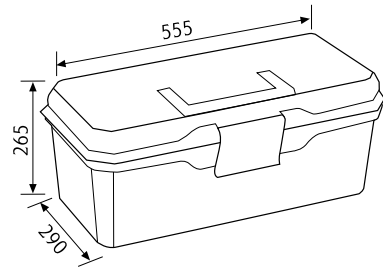

24"

ORGANİZERLİ MAESTRO
MAESTRO WITH ORGANIZER

Kod No
Art. Code **P.0.09**

EAN / 8691311981250

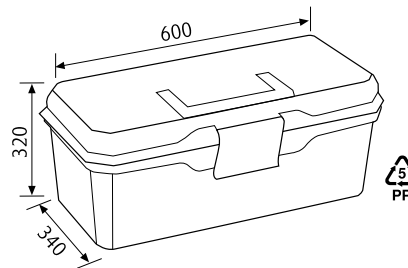

BASIC SERİSİ / BASIC SERIES



13"

MAESTRO SEPETLİ
MAESTRO BASIC

Kod No
Art. Code **P.S.06**

EAN / 8691311494958

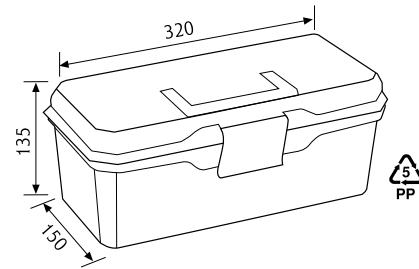

12 Adet / Pcs

16"

MAESTRO SEPETLİ
MAESTRO BASIC

Kod No
Art. Code **P.S.07**

EAN / 8691311487646

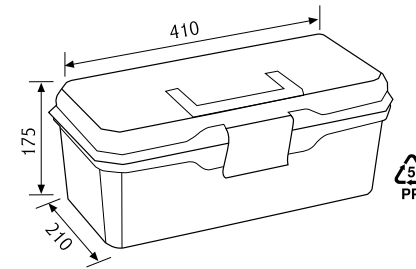

12 Adet / Pcs

19"

MAESTRO SEPETLİ
MAESTRO BASIC

Kod No **P.S.05**
Art. Code
EAN / 8691311493036

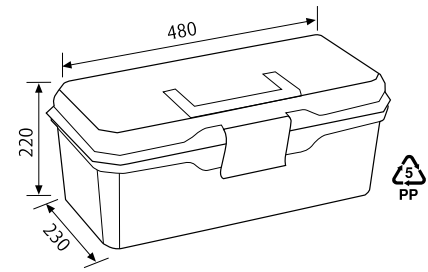

22"

MAESTRO SEPETLİ
MAESTRO BASIC

Kod No **P.S.08**
Art. Code
EAN / 8691311453894

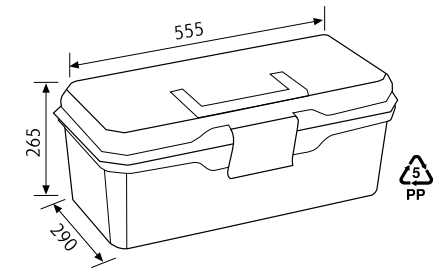



17"

RAFLI PORT-BAG
CANTILEVER PORT-BAG

Kod No **P.R.07**
Art. Code

EAN / 8691311131112

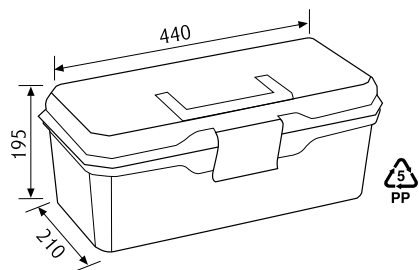

20"

RAFLI PORT-BAG
CANTILEVER PORT-BAG

Kod No
Art. Code **P.R.05**

EAN / 8691311253012

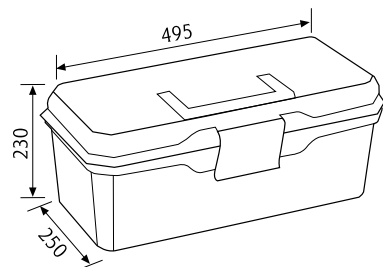
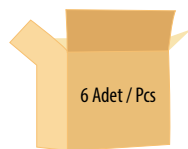

MOBİL SERİ / MOBIL SERIES



18"

PORT-BAG MOBİL ÇİFT ÇANTA
PORT-BAG ROLLING DOUBLE TOOL-BOX

Kod No P.O.10M
Art. Code
EAN / 8691311918478

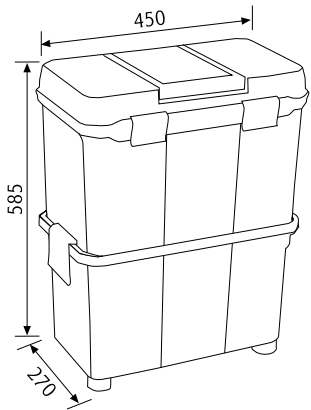

24"

ORGANİZERLİ MOBİL
MOBILE WITH ORGANIZER

Kod No **P.O.09M**
Art. Code
EAN / 8691311763481

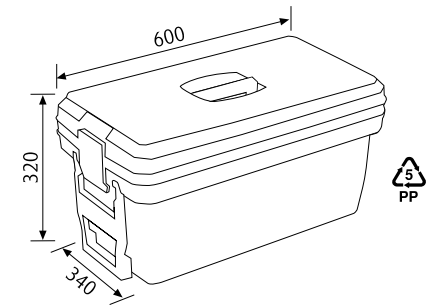

PLASTİK TAKIM ÇANTALARI / PLASTIC TOOL BOXES



PORT-BAG®

EL ALETİ ÇANTALARI / POWER TOOL BOXES



EL ALETİ ÇANTASI

POWER TOOLS BOX

Kod No **P.M.01**
Art. Code

EAN / 8691311061167

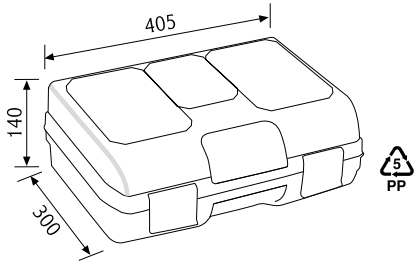

ORGANİZERLİ EL ALETİ ÇANTASI

POWER TOOLS BOX WITH ORGANIZER

Kod No **P.M.02**
Art. Code

EAN / 8691311061150

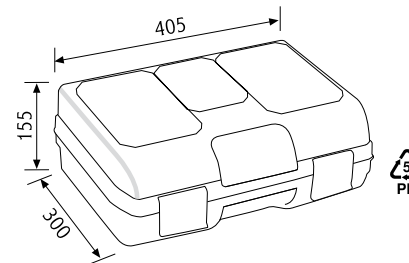

JUMBO EL ALETİ ÇANTASI

JUMBO POWER TOOLS BOX

Kod No **P.V.01**
Art. Code

EAN / 8691311002482

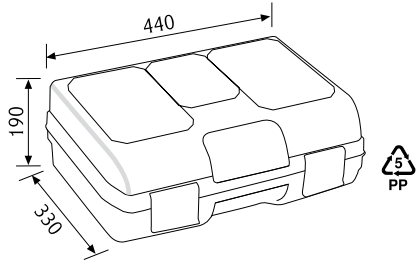

ÇOK AMAÇLI ÇANTA
GENERAL PURPOSE CASE

Kod No **T.K.50**
Art. Code

EAN / 3321369987274

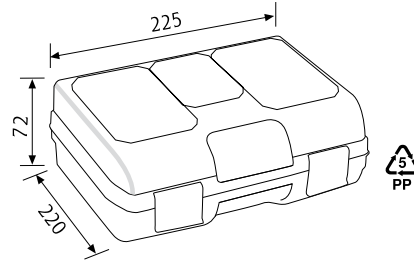

ÇOK AMAÇLI ÇANTA
GENERAL PURPOSE CASE

Kod No **T.K.70**
Art. Code
EAN / 3321369986192

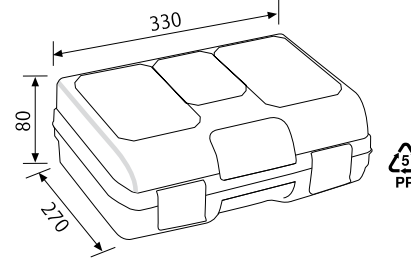

ÇOK AMAÇLI ÇANTA
GENERAL PURPOSE CASE

Kod No **T.K.100**
Art. Code
EAN / 3321369987298

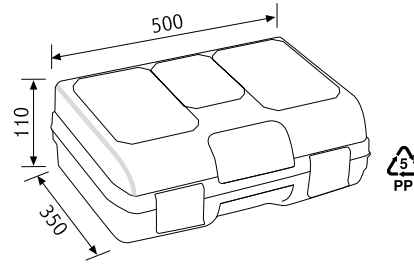









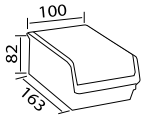

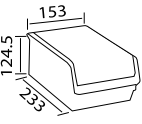
AVADANLIKLAR / STORAGE BINS

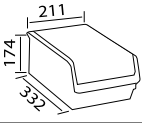

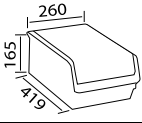
STAR AVADANLIKLAR

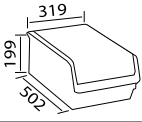
STAR STORAGE BINS

	L x W x H	ADET / PCS	EAN
SA.02			3321360008749
SA.03			3321360008756
SA.04			3321360008763
SA.04-L			3321360008770
SA.05			3321360008787



Ağır Maksat Kullanım
Ultra Heavy Duty



SA.05



SA.04-L



SA.04



SA.03



SA.02



SA.05



SA.04-L



SA.04



SA.03



SA.02



SA 05



SA.04-L



SA.04



SA.03



SA.02

PROFESYONEL AVADANLIKLAR

PROFESSIONAL STORAGE BINS









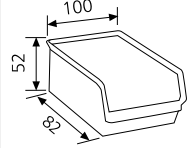

P.A.01

P.A.02

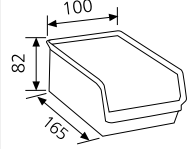
P.A.03

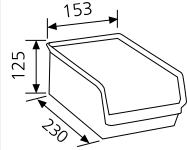
P.A.04

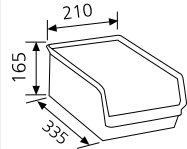
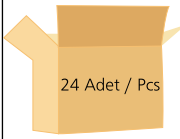
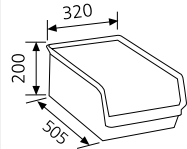
P.A.05

	L x W x H	ADET / PCS	EAN
P.A.01		 54 Adet / Pcs	8691311060016
P.A.02		 48 Adet / Pcs	8691311060023
P.A.03		 48 Adet / Pcs	8691311060054
P.A.04		 24 Adet / Pcs	8691311060283
P.A.05		 4 Adet / Pcs	8691311253005

Profesyonel Kullanım
Professional Duty



	L x W x H	ADET / PCS	EAN
T.A.02		 36 Adet / Pcs	3321360001207
T.A.03		 24 Adet / Pcs	3321360001214
T.A.04		 12 Adet / Pcs	3321360001221
T.A.05		 4 Adet / Pcs	3321360001238



Hafif Maksat Kullanım
DIY Purposes

TEKNİ AVADANLIK SERİSİ

TEKNI STORAGE BINS SERIES



T.A.02

T.A.03

T.A.04

T.A.05

PLASTIK VE METAL ASKILI DUVAR SETLERI PLASTIC AND METAL RAILED WALL MOUNT SETS

PAS 01  EAN / 8691311771226



PAS 02  EAN / 8691311866571

SAS 01  EAN / 8691311771134

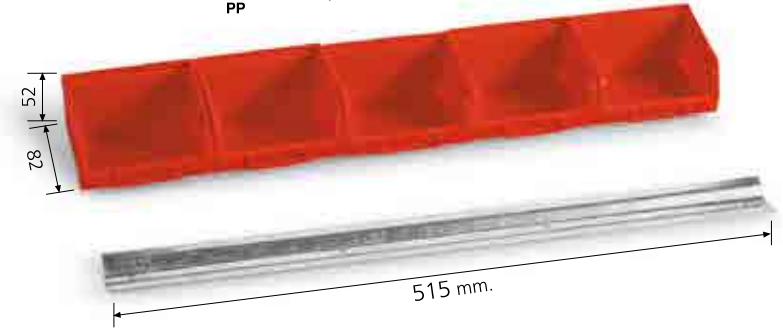

SAS 03  EAN / 8691311866816



SAS 02  EAN / 8691311805358

PLASTİK ÇEKMECE SETLERİ / PLASTIC CABINETS



MODÜLER ÇEKMECE GRUBU
MODULAR DRAWERS GROUP

PÇ.010



PÇ.011



PÇ.012











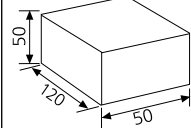

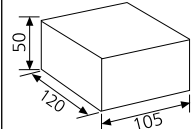
PÇ.013

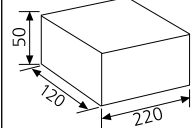

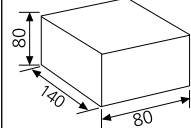
PÇ.014

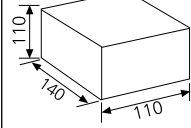





	L x W x H	ADET / PCS	EAN
PÇ.010		 128 Adet / Pcs	8691311060030
PÇ.011		 64 Adet / Pcs	8691311070022
PÇ.012		 32 Adet / Pcs	8691311070015
PÇ.013		 80 Adet / Pcs	8691311021024
PÇ.014		 60 Adet / Pcs	8691311253043

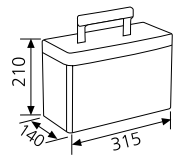
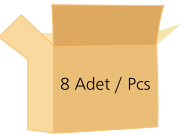
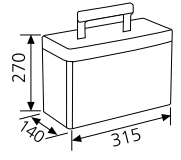

CABY SETLER

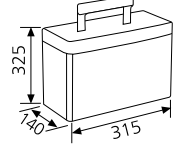
CABY SETS

	L x W x H	ADET / PCS	EAN
P.L01		 8 Adet / Pcs	3321361150027
P.L02		 8 Adet / Pcs	8691311515226
P.L03		 8 Adet / Pcs	3321361150010



PL.01
Caby-Set 3/11



PL.02
Caby-Set 4/19



PL.03
Caby-Set 5/27

CABY SETLER

CABY SETS

 PL.06
Caby-Set 9/46

 PL.05
Caby-Set 7/43

 PL.04
Caby-Set 6/29

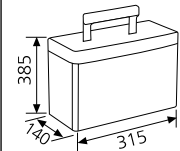
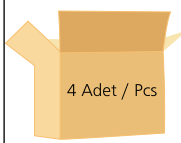
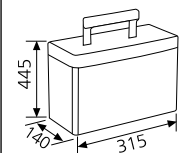
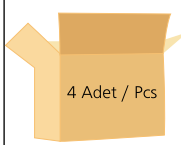
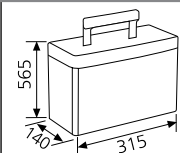
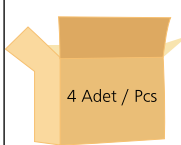
	L x W x H	ADET / PCS	EAN
P.L04		 4 Adet / Pcs	8691311515295
P.L05		 4 Adet / Pcs	3321361150003
P.L06		 4 Adet / Pcs	8691311515271



	L x W x H	ADET / PCS	EAN
PH.01			8691311000104
PH.02			8691311000111

RENK



HOBİ SETLER

HOBBY SETS

PH.01



P.Ç.010 x 4 Adet



P.Ç.011 x 6 Adet

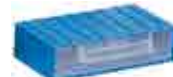

P.Ç.012 x 1 Adet

PH.02



P.Ç.010 x 16 Adet



P.Ç.011 x 12 Adet







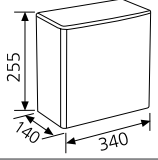

P.Ç.012 x 2 Adet

HOBİ SETLER
HOBBY SETS

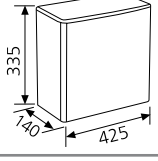
PH.03



RENK	L x W x H	ADET / PCS	EAN
		 8 Adet / Pcs	8691311000128
		 4 Adet / Pcs	8691311000135
			
			
			



P.Ç.013 x 12 Adet



P.Ç.013 x 20 Adet







PH.04

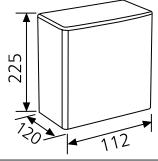

HOBİ SETLER

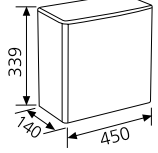
HOBBY SETS

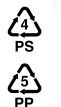
	L x W x H	ADET / PCS	EAN	RENK
PH.05		 24 Adet / Pcs	8691311061112	
PH.06		 4 Adet / Pcs	8691311200016	

PH.05



P.Ç.010 x 2 Adet



P.Ç.011 x 3 Adet

PH.06



P.Ç.014 x 12 Adet

BÜYÜK AVADANLIK ÇEKMECESİ

HUGE STOCKER

Kod No **BÇ.015**
Art. Code

EAN / 8691311241163

Kullanım Alanları:

Medikal, elektrik, elektronik v.b. tüm imalat sanayilerinde, evinizde, teknenizde, tüm teknik servislerde stokladığınız malzemeleri tozdan korumasının yanısıra 15 kg./adet kapasite ile estetik ve kullanışlı, profesyonel bir çözüm sunar.

For medical, electric, electronic, all sort of warehouses, home, boats, and services usage. To stock with an esthetical outlook and professional solutions, with a capacity of 15 kg/item.

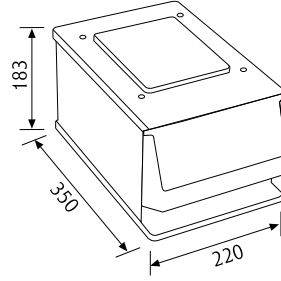

12 Adet / Pcs

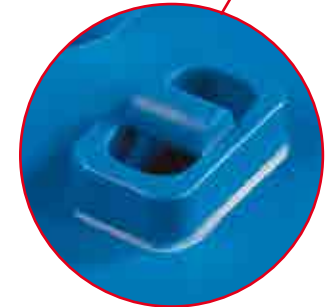

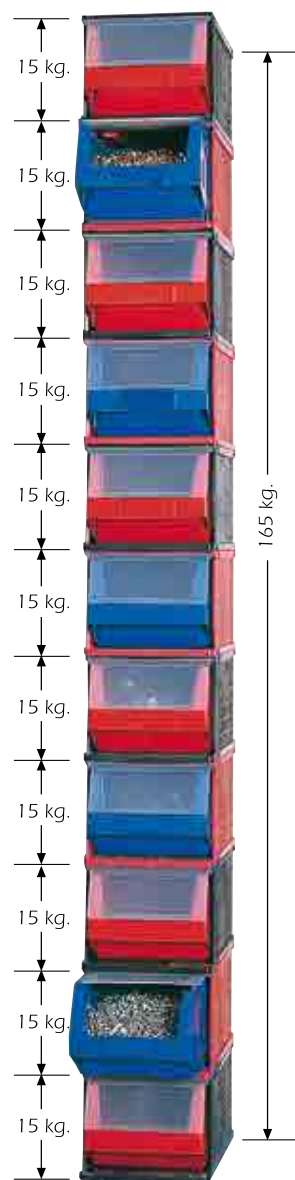

ORGANİZERLER / ORGANIZERS



ORGANİZERLER

ORGANIZERS

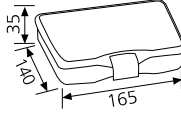
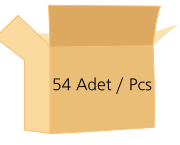
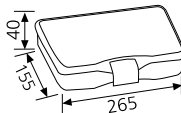
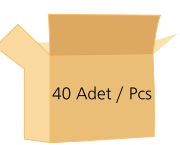
	L x W x H	ADET / PCS	EAN
O.R.06		 54 Adet / Pcs	3321369812002
O.R.07	 O.R.06	 40 Adet / Pcs	3321360000019





Poly Organizer 1/8



O.R.07
Poly Organizer 2/12

ORGANİZERLER
ORGANIZERS

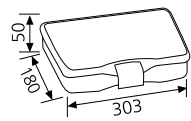
RENK

	L x W x H	ADET / PCS	EAN
O.R.08		 24 Adet / Pcs	8691311081066







O.R.08
Poly Organizer 3/8

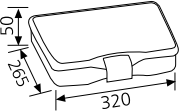

ORGANİZERLER

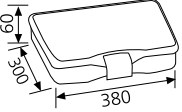
ORGANIZERS

	L x W x H	ADET / PCS	EAN
P.P.01		 18 Adet / Pcs	3321369942013
P.P.02		 16 Adet / Pcs	3321369942020





P.P.01
Poly Organizer 32



P.P.02
Poly Organizer 38

ORGANİZERLER

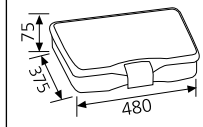



ORGANIZERS

	L x W x H	ADET / PCS	EAN
P.P.03		 10 Adet / Pcs	3321369942037

 P.P.03
Poly Organizer 48

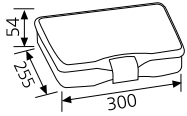
ORGANİZERLER

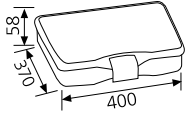

ORGANIZERS

	L x W x H	ADET / PCS	EAN
P.P.04		 18 Adet / Pcs	8412524021690
P.P.05		 12 Adet / Pcs	8412524021713

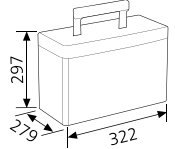

ORGANİZERLER
ORGANIZERS

P.P.08
Poly Organizer Set

	L x W x H	ADET / PCS	EAN
P.P.08		 1 Adet / Pcs	8691311071104



MODÜLER GRUPLAR / MODULAR GROUPS



MASA ÜSTÜ MODÜLLER

DESKTOP

MAS 10 
PP



P.A.01 x 4 Adet



P.A.02 x 12 Adet

MAS 20 
PP



P.A.01 x 4 Adet



P.A.02 x 12 Adet

MAS 30 
PP



P.A.03 x 5 Adet



P.A.04 x 8 Adet

MASA ÜSTÜ MODÜL

DESKTOP



P.Ç.010 x 48 Adet



P.Ç.011 x 24 Adet

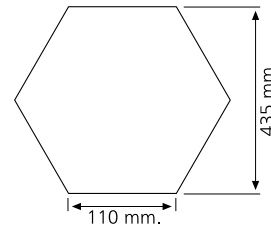

ÇMÜ.10



METAL AVADANLIK DOLAPLARI
STORAGE CABINETS

AD.02

P.A.02 x 84 Adet

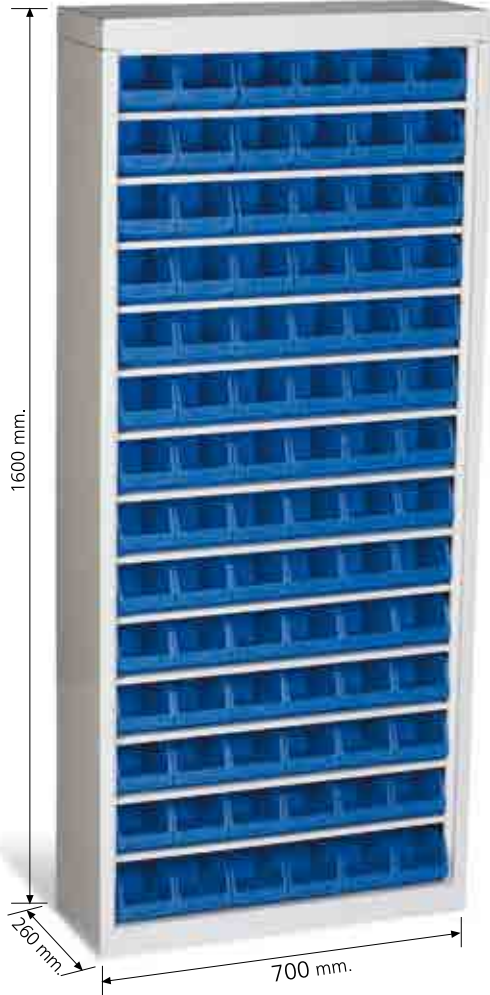

AD.03

P.A.03 x 40 Adet



AD.04

P.A.04 x 32 Adet



KAPAKLI METAL AVADANLIK DOLAPLARI
STORAGE CABINETS WITH DOOR

K.A.D.01



P.Ç.10 x 42 Adet



P.Ç.11 x 24 Adet



P.Ç.12 x 9 Adet



P.Ç.13 x 18 Adet



P.Ç.14 x 14 Adet



P.A.04 x 12 Adet

KAPAKLI METAL AVADANLIK DOLAPLARI
STORAGE CABINETS WITH DOOR

K.A.D.02



P.A.02 x 84 Adet



KAPAKLI METAL AVADANLIK DOLAPLARI
STORAGE CABINETS WITH DOOR

K.A.D.03



P.A.03 x 40 Adet



KAPAKLI METAL AVADANLIK DOLAPLARI
STORAGE CABINETS WITH DOOR

K.A.D.04



P.A.04 x 32 Adet



METAL AVADANLIK RAFLARI
STORAGE SHELVES



P.A.03 x 48 Adet

AR.03

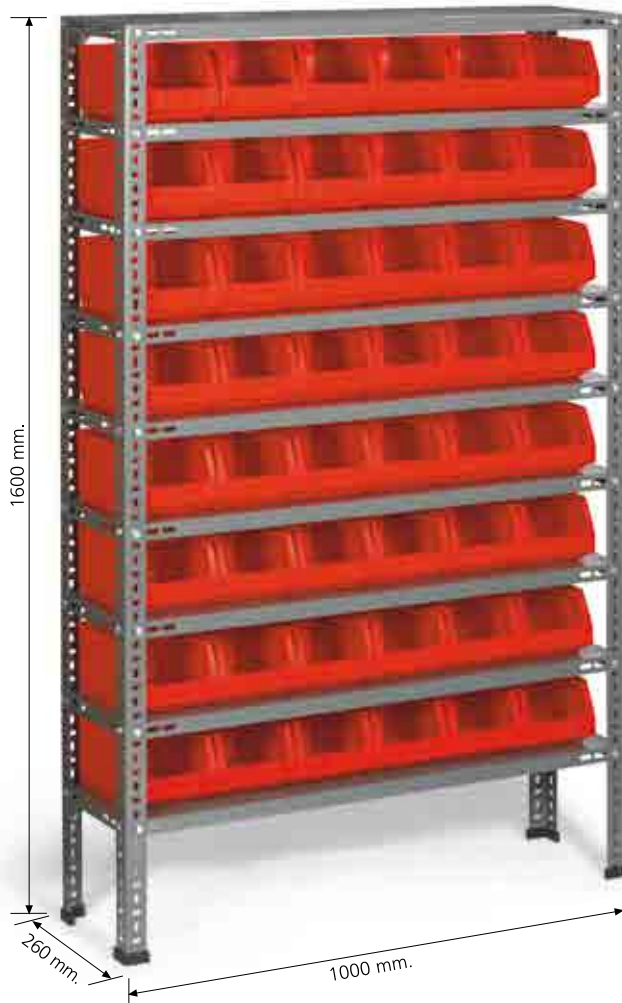

P.A.04 x 28 Adet

AR.04



P.A.05 x 18 Adet

AR.05



DUVAR TIPI SABİT

WALL TYPE FIX

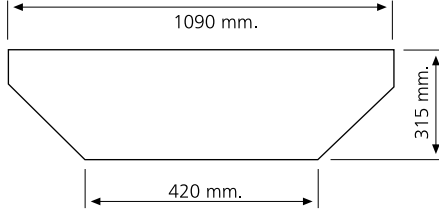

P.Ç.011 x 216 Adet

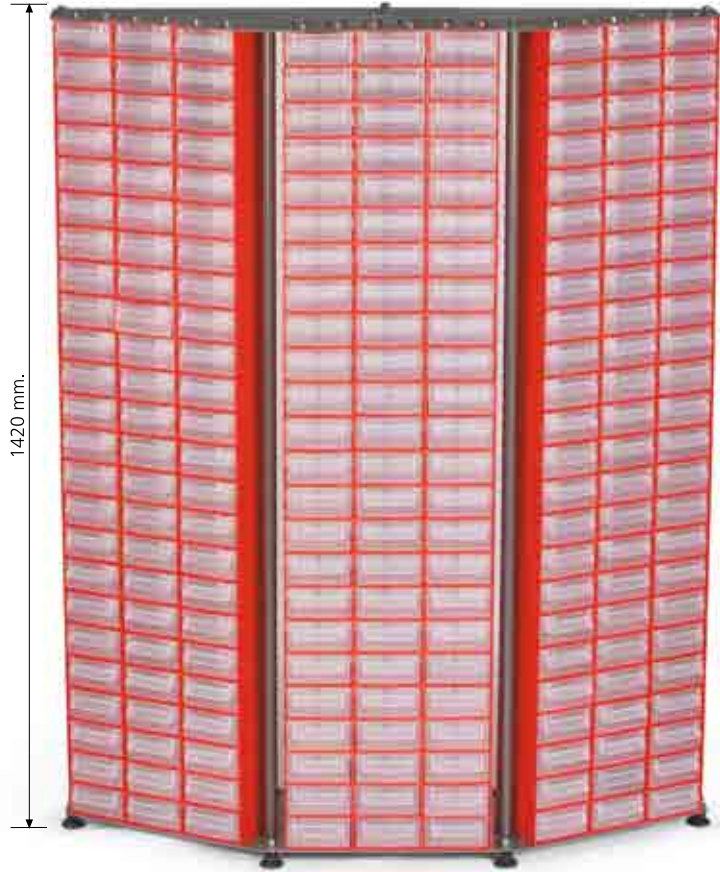

ÇD.11



DUVAR TİPİ SABİT

WALL TYPE FIX

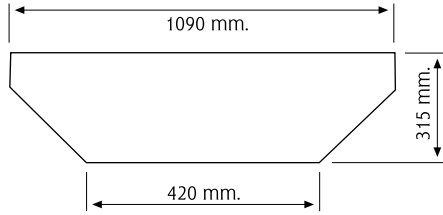

P.Ç.013 x 192 Adet

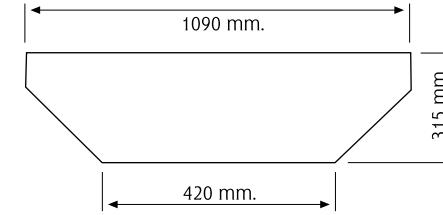

P.Ç.014 x 108 Adet

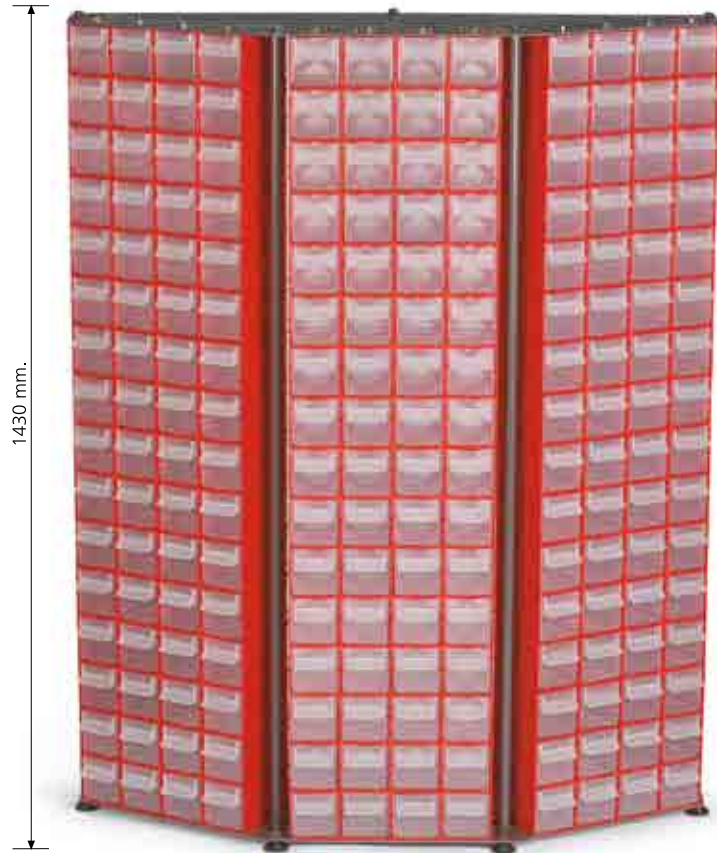

ÇD.13

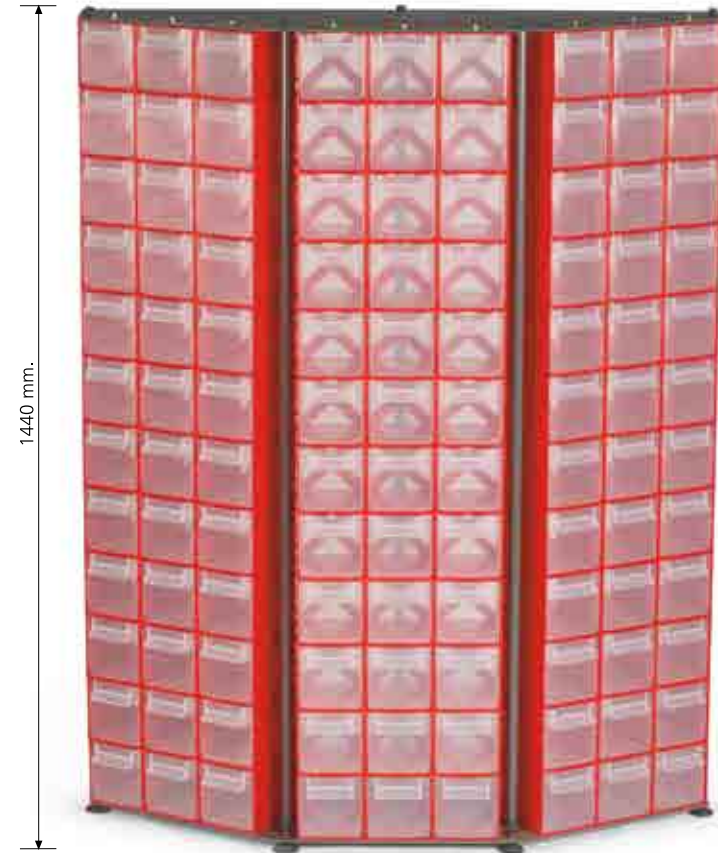

ÇD.14

DUVARDİBİ SABİT AVADANLIK MODÜLLER

WALL MOUNTS

MAK 20 
PP



MAK 30 
PP



GEZER DÖNER
ALL SIDE MOVABLE

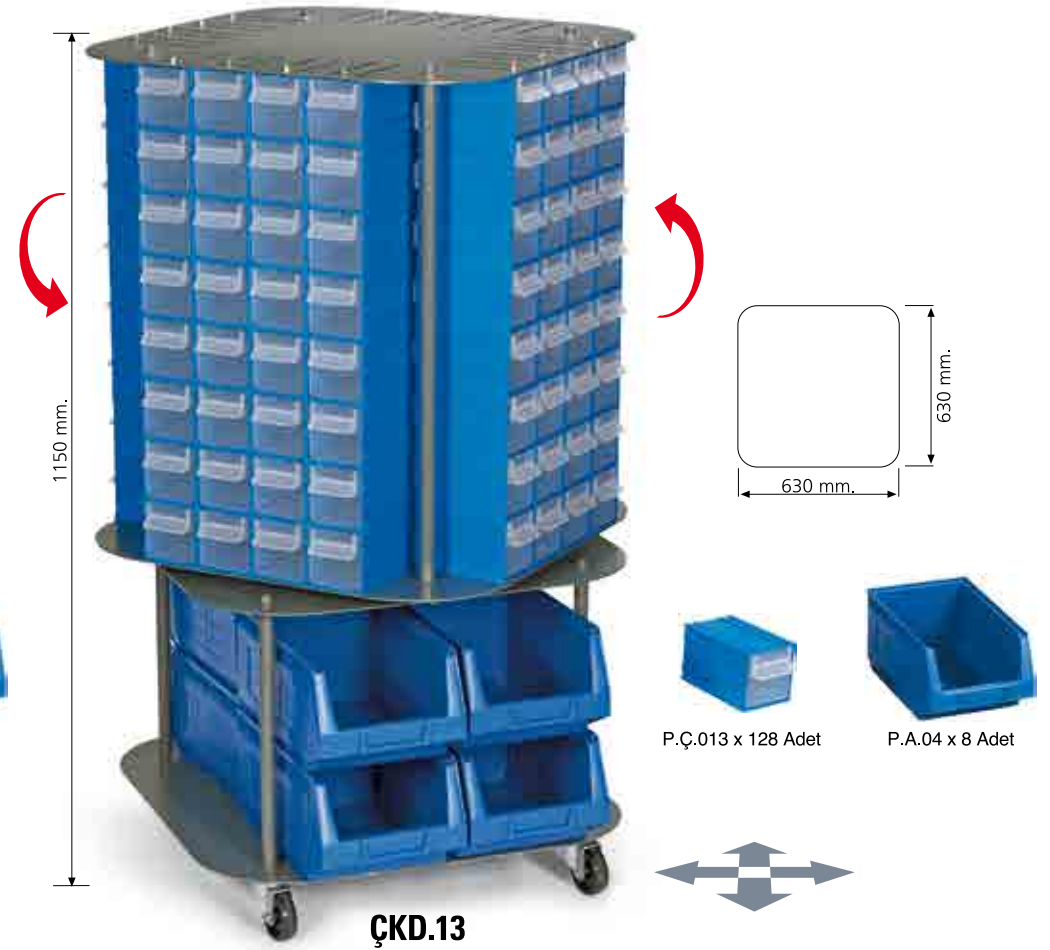
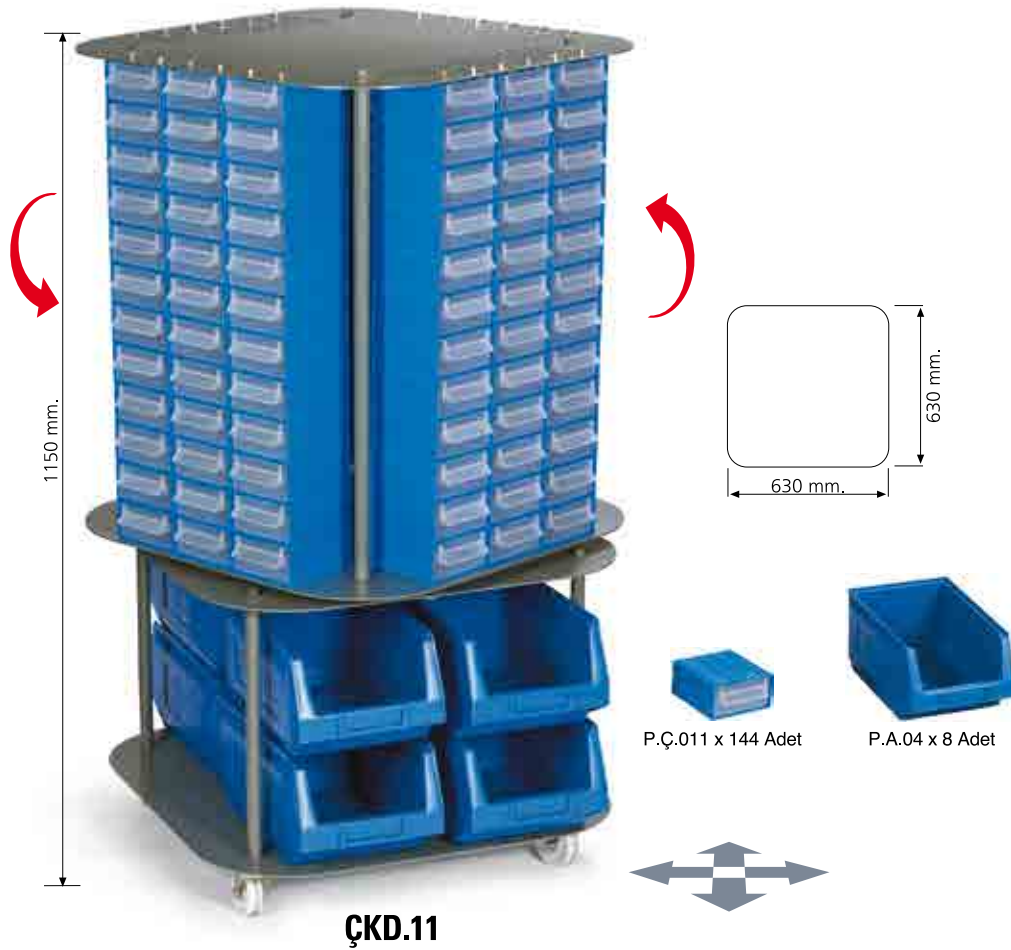

MODÜLER SİSTEMLER

MODULAR SYSTEMS

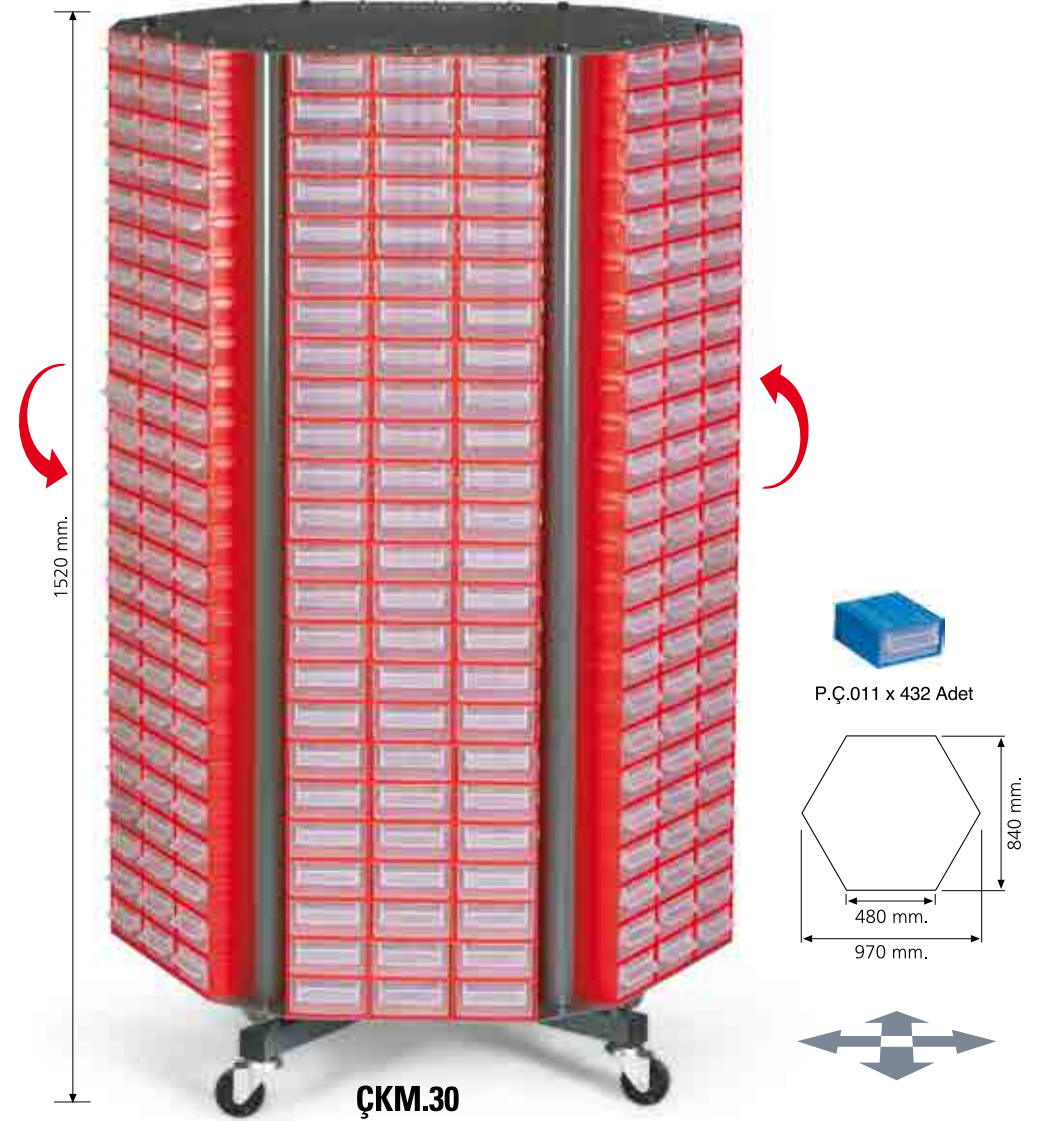

EKSENEL MODÜL
CENTRAL MODULE

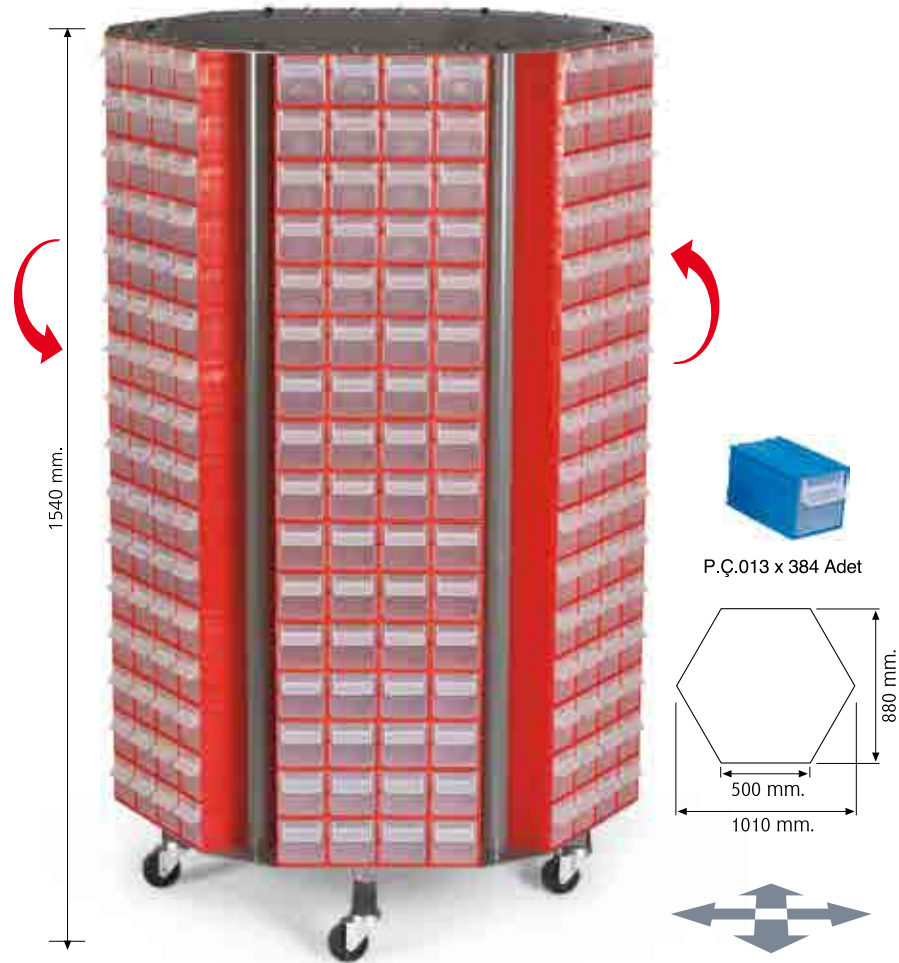

ÇKM.40

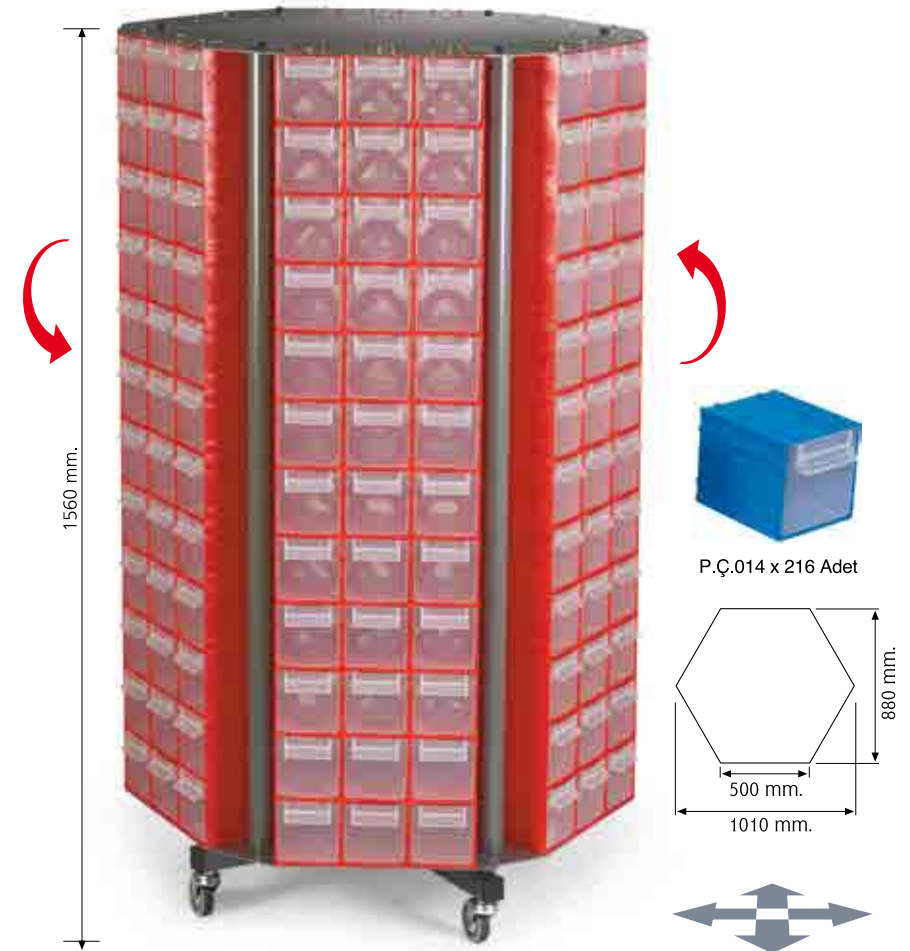

ÇKM.50

TEKERLEKLİ AVADANLIK MODÜLLERİ
MOBILE MODULES

MAT 20 

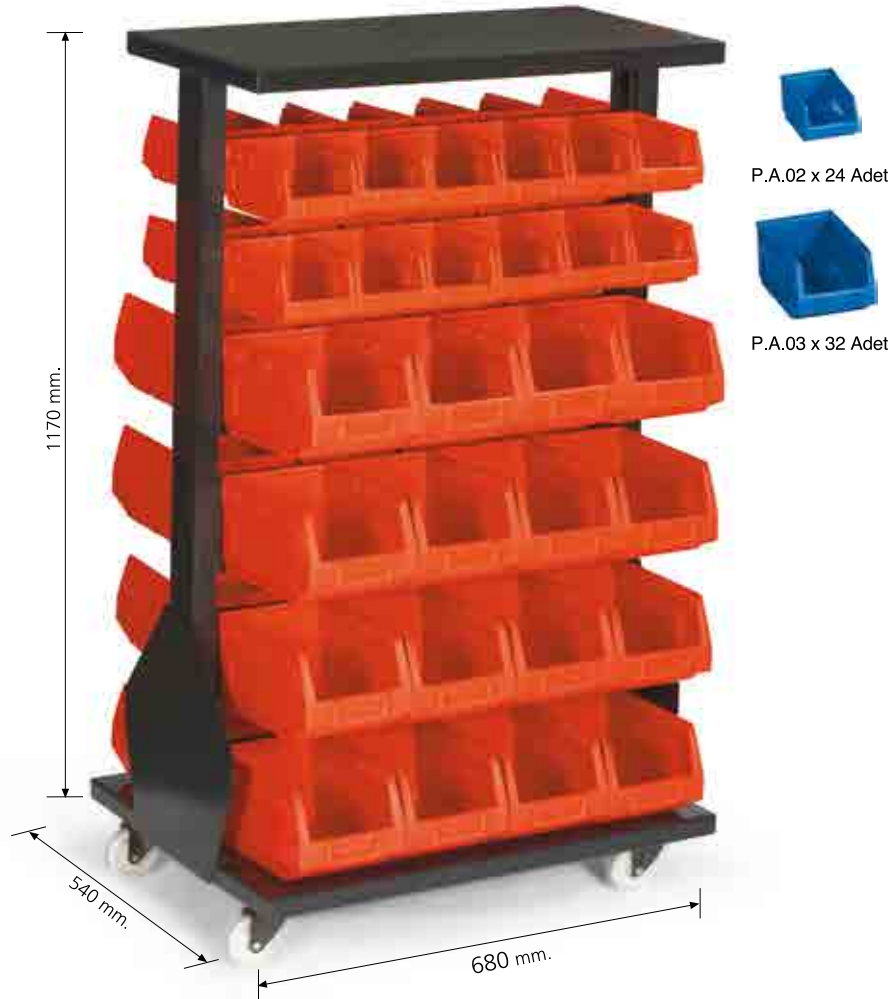

MAT 30 

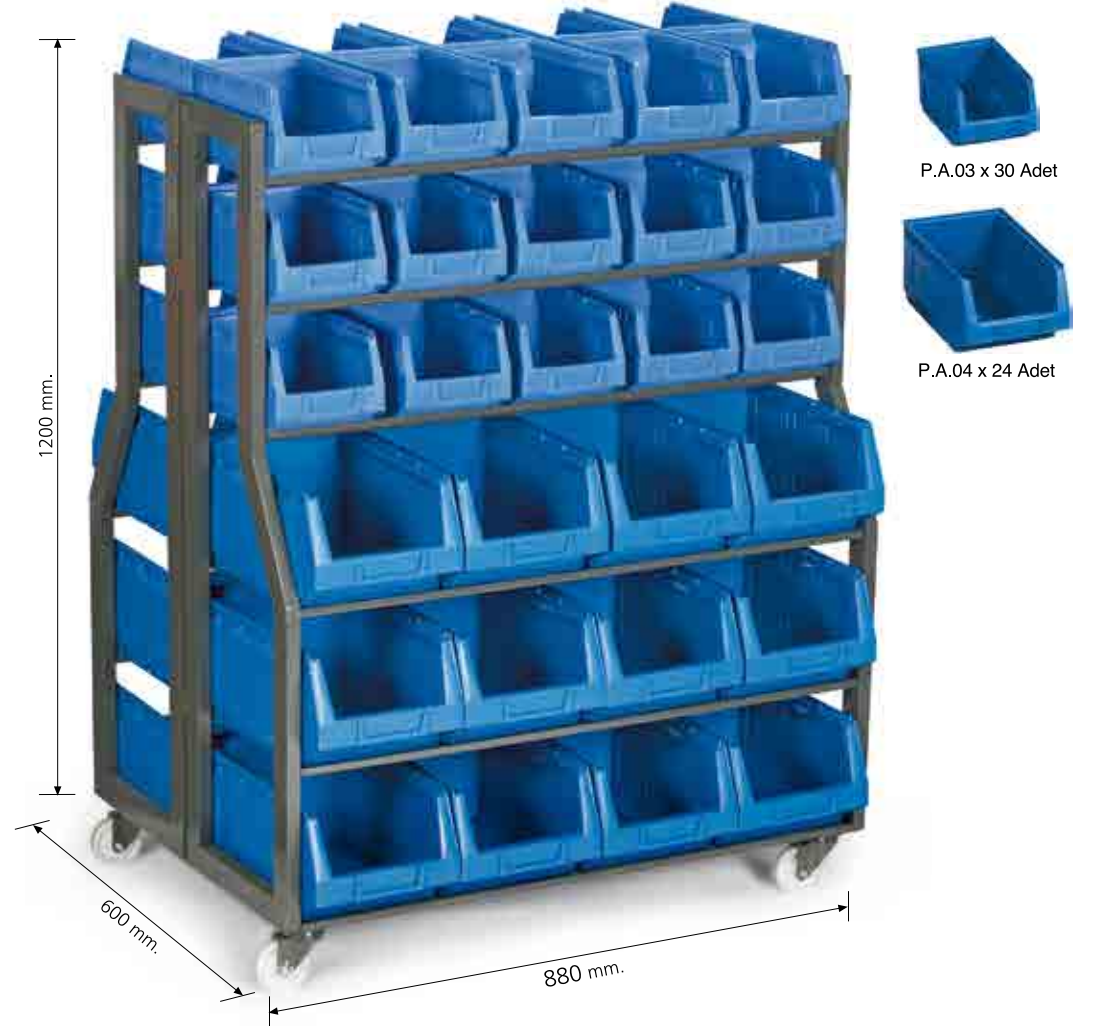



NSF International Strategic Registrations

789 North Dixboro Road, Ann Arbor, Michigan 48105
(888) NSF-9000 | www.nsf-isr.org

Certificate of Registration

This certifies that the Quality Management System of

ISIK KALIP SANAYI TICARET VE LIMITED SIRKETI

Atatürk Organize Sanayi Bölgesi Sok. No:33
Çiğli, Izmir, Turkey

has been assessed by NSF-ISR and found to be in conformance to the following standard(s):

ISO 9001:2008

Scope of Registration:

Design, Manufacturing and Sales of Plastic Storage Equipment



Certificate Number: C0124375-IS1
Certificate Issue Date: 17-MAY-2013
Registration Date: 28-JUN-2011
Expiration Date *: 27-JUN-2014

William Niedzwiecki,
President & General Manager,
NSF-ISR, Ltd.



















PORT-BAG®

ÜRÜN BİLGİLERİ PRODUCT DATA

* Barkod numaraları ürün renklerine göre değişebilmektedir.
Ean number are different according to product colours
** Yükleme adetleri tahminidir / These figures are estimated quantities
*** Kesin adetlerdir / These figures are exact quantities

Ürün Kodu / Product Code	AD.02	AD.03	AD.04	AR.03	AR.04	AR.05	BÇ.015
Sayfa / Page	74	74	74	79	79	79	62
En (Width) mm	260	260	400	260	300	430	350
Boy (Lentgh) mm	700	700	900	1.000	930	1.060	220
Yükseklik (High) mm	1.600	1.600	1.600	1.600	1.600	1.600	183
Koli İçi Adeti (pcs/per box)	1	1	1	1	1	1	12
Koli Hacmi (volume per box m ³)	0,303	0,322	0,588	0,445	0,533	0,889	0,192
Adet / pcs in 20" (28,5 m ³)	93	88	48	64	53	32	1.776
Adet / pcs in 40" DC (61 m ³)	201	189	103	137	114	68	3.804
Adet / pcs in 40" HC (69 m ³)	227	214	117	155	129	77	4.296
Adet / pcs in TRUCK OPTIMA (78,5 m ³)	258	243	133	176	147	88	4.896
Barkod / EAN code*	 8 691311 120017	 8 691311 120048	 8 691311 120079	 8 691311 120109	 8 691311 120130	 8 691311 120161	 8 691311 1241163







Ürün Kodu / Product Code	CD.11	CD.13	CD.14	CKD.11	CKD.13	CKD.14	CKM.30
Sayfa / Page	80	81	81	83	83	84	84
En (Width) mm	315	315	315	630	630	630	840
Boy (Lentgh) mm	1.090	1.090	1.090	630	630	630	970
Yükseklik (High) mm	1.420	1.430	1.440	1.150	1.150	1.150	1.520
Koli İçi Adeti (pcs/per box)	1	1	1	1	1	1	1
Koli Hacmi (volume per box m ³)	0,488	0,499	0,494	0,595	0,595	0,595	1,238
Adet / pcs in 20" (28,5 m ³)	58	57	57	47	47	47	23
Adet / pcs in 40" DC (61 m ³)	125	122	123	102	102	102	49
Adet / pcs in 40" HC (69 m ³)	141	138	139	115	115	115	55
Adet / pcs in TRUCK OPTIMA (78,5 m ³)	161	157	158	131	131	131	63
Barkod / EAN code*	 8 691311 120192	 8 691311 120222	 8 691311 120253	 8 691311 120284	 8 691311 120314	 8 691311 120345	 8 691311 120376









PORT-BAG®

ÜRÜN BİLGİLERİ PRODUCT DATA

* Barkod numaraları ürün renklerine göre değişebilmektedir.
Ean number are different according to product colours
** Yükleme adetleri tahminidir / These figures are estimated quantities
*** Kesin adetlerdir / These figures are exact quantities

Ürün Kodu / Product Code	CKM.40	CKM.50	CM.01	CM.02	CMU.10	CP.01	CP.02
Sayfa / Page	85	85	10	11	73	7	8
En (Width) mm	880	880	260	275	435	270	290
Boy (Lentgh) mm	1.010	1.010	430	530	110	380	500
Yükseklik (High) mm	1.540	1.560	250	295	510	220	240
Koli İçi Adeti (pcs/per box)	1	1	2	2	1	3	3
Koli Hacmi (volume per box m ³)	1,408	1,396	0,063	0,091	0,112	0,072	0,114
Adet / pcs in 20" (28,5 m ³)	20	20	902	628	254	1.191	747
Adet / pcs in 40" DC (61 m ³)	43	43	1.932	1.344	544	2.550	1.599
Adet / pcs in 40" HC (69 m ³)	49	49	2.184	1.520	616	2.883	1.809
Adet / pcs in TRUCK OPTIMA (78,5 m ³)	55	56	2.486	1.730	700	3.282	2.061
Barkod / EAN code*	 8 691311 120406	 8 691311 120437	 8 691311 960187	 8 691311 960217	 8 691311 120468	 8 691311 920167	 8 691311 920204







Ürün Kodu / Product Code	DP.01	KAD.01	KAD.02	KAD.03	KAD.04	MAK.20	MAK.30
Sayfa / Page	5	75	76	77	78	82	82
En (Width) mm	147	400	260	260	400	290	285
Boy (Lentgh) mm	431	900	700	700	900	680	880
Yükseklik (High) mm	590	1.600	1.600	1.600	1.600	1.070	1.090
Koli İçi Adeti (pcs/per box)	1	1	1	1	1	1	1
Koli Hacmi (volume per box m ³)	0,037	0,655	0,297	0,284	0,635	0,250	0,324
Adet / pcs in 20" (28,5 m ³)	762	43	95	100	44	114	87
Adet / pcs in 40" DC (61 m ³)	1.631	93	205	214	96	244	188
Adet / pcs in 40" HC (69 m ³)	1.845	105	232	242	108	276	212
Adet / pcs in TRUCK OPTIMA (78,5 m ³)	2.100	119	264	275	123	314	242
Barkod / EAN code*	 8 691311 930104	 8 691311 120499	 8 691311 120529	 8 691311 120550	 8 691311 120581	 8 691311 120611	 8 691311 120642









PORT-BAG®

ÜRÜN BİLGİLERİ PRODUCT DATA

* Barkod numaraları ürün renklerine göre değişebilmektedir.
Ean number are different according to product colours
** Yükleme adetleri tahminidir / These figures are estimated quantities
*** Kesin adetlerdir / These figures are exact quantities

Ürün Kodu / Product Code	MAS.10	MAS.20	MAS.30	MAT.20	MAT.30	ML.03	ML.04
Sayfa / Page	72	72	72	86	86	20	21
En (Width) mm	270	285	295	540	600	255	295
Boy (Lentgh) mm	420	420	880	680	880	480	555
Yükseklik (High) mm	435	515	520	1.170	1.200	230	265
Koli İçi Adeti (pcs/per box)	1	1	1	1	1	9	6
Koli Hacmi (volume per box m ³)	0,026	0,037	0,154	0,430	0,708	0,229	0,249
Adet / pcs in 20" (28,5 m ³)	1.091	766	184	66	40	1.116	684
Adet / pcs in 40" DC (61 m ³)	2.337	1.640	395	141	86	2.394	1.464
Adet / pcs in 40" HC (69 m ³)	2.643	1.855	447	160	97	2.709	1.662
Adet / pcs in TRUCK OPTIMA (78,5 m ³)	3.007	2.111	509	182	110	3.078	1.890
Barkod / EAN code*	 8 691311 120673	 8 691311 120703	 8 691311 120734	 8 691311 120765	 8 691311 120796	 8 691311 904839	 8 691311 902514







Ürün Kodu / Product Code	ML.05	OR.06	OR.07	OR.08	PA.01	PA.02	PA.03
Sayfa / Page	22	65	65	66	52	52	52
En (Width) mm	314	140	155	180	82	165	230
Boy (Lentgh) mm	607	165	265	303	100	100	153
Yükseklik (High) mm	277	35	40	50	52	82	125
Koli İçi Adeti (pcs/per box)	1	54	40	24	54	48	48
Koli Hacmi (volume per box m ³)	0,054	0,048	0,070	0,069	0,022	0,054	0,176
Adet / pcs in 20" (28,5 m ³)	527	32.130	16.360	9.936	70.956	25.248	7.728
Adet / pcs in 40" DC (61 m ³)	1.129	68.796	35.000	21.264	151.848	54.048	16.560
Adet / pcs in 40" HC (69 m ³)	1.277	77.814	39.600	24.048	171.774	61.104	18.768
Adet / pcs in TRUCK OPTIMA (78,5 m ³)	1.453	88.560	45.040	27.360	195.426	69.552	21.360
Barkod / EAN code*	 8 691311 905515	 3 321369 812002	 3 321360 000019	 8 691311 081066	 8 691311 060016	 8 691311 060023	 8 691311 060054









PORT-BAG®

ÜRÜN BİLGİLERİ PRODUCT DATA

* Barkod numaraları ürün renklerine göre değişebilmektedir.
Ean number are different according to product colours
** Yükleme adetleri tahminidir / These figures are estimated quantities
*** Kesin adetlerdir / These figures are exact quantities

Ürün Kodu / Product Code	PA.04	PA.05	PAS.01	PAS.02	PÇ.010	PÇ.011	PÇ.012
Sayfa / Page	52	52	54	54	56	56	56
En (Width) mm	335	505	82	165	120	120	120
Boy (Lentgh) mm	210	320	450	450	50	105	220
Yükseklik (High) mm	165	200	52	82	50	50	50
Koli İçi Adeti (pcs/per box)	24	4	16	15	128	64	32
Koli Hacmi (volume per box m ³)	0,238	0,108	0,033	0,087	0,063	0,063	0,063
Adet / pcs in 20" (28,5 m ³)	2.856	1.052	13.648	4.935	58.112	29.056	14.528
Adet / pcs in 40" DC (61 m ³)	6.144	2.252	29.232	10.560	124.416	62.208	31.104
Adet / pcs in 40" HC (69 m ³)	6.936	2.544	33.056	11.940	140.800	70.400	35.200
Adet / pcs in TRUCK OPTIMA (78,5 m ³)	7.896	2.896	37.616	13.590	160.128	80.064	40.032
Barkod / EAN code*	 8 691311 060283	 8 691311 253005	 8 691311 771226	 8 691311 866571	 8 691311 060030	 8 691311 070022	 8 691311 070015







Ürün Kodu / Product Code	PÇ.013	PÇ.014	PE.01	PE.02	PE.03	PE.04	PH.01
Sayfa / Page	56	56	24	25	26	27	59
En (Width) mm	140	140	160	200	255	295	120
Boy (Lentgh) mm	80	110	320	400	480	555	225
Yükseklik (High) mm	80	110	130	175	230	265	280
Koli İçi Adeti (pcs/per box)	80	60	18	18	10	8	8
Koli Hacmi (volume per box m ³)	0,099	0,066	0,095	0,175	0,157	0,250	0,076
Adet / pcs in 20" (28,5 m ³)	22.960	25.800	5.400	2.916	1.810	904	3.000
Adet / pcs in 40" DC (61 m ³)	49.280	55.260	11.556	6.264	3.890	1.944	6.432
Adet / pcs in 40" HC (69 m ³)	55.760	62.520	13.068	7.092	4.400	2.200	7.280
Adet / pcs in TRUCK OPTIMA (78,5 m ³)	63.360	71.160	14.868	8.064	5.000	2.504	8.280
Barkod / EAN code*	 8 691311 021024	 8 691311 253043	 8 691311 083473	 8 691311 092390	 8 691311 093748	 8 691311 092130	 8 691311 000104









PORT-BAG®

ÜRÜN BİLGİLERİ PRODUCT DATA

* Barkod numaraları ürün renklerine göre değişebilmektedir.
Ean number are different according to product colours
** Yükleme adetleri tahminidir / These figures are estimated quantities
*** Kesin adetlerdir / These figures are exact quantities

Ürün Kodu / Product Code	PH.02	PH.03	PH.04	PH.05	PH.06	PL.01	PL.02
Sayfa / Page	59	60	60	61	61	57	57
En (Width) mm	120	140	140	120	140	140	140
Boy (Lentgh) mm	450	340	425	112	450	315	315
Yükseklik (High) mm	335	255	335	225	339	210	270
Koli İçi Adeti (pcs/per box)	4	8	4	24	4	8	8
Koli Hacmi (volume per box m ³)	0,091	0,121	0,105	0,090	0,106	0,080	0,102
Adet / pcs in 20" (28,5 m ³)	1.252	1.880	1.080	7.536	1.076	2.848	2.240
Adet / pcs in 40" DC (61 m ³)	2.680	4.032	2.312	16.176	2.304	6.104	4.792
Adet / pcs in 40" HC (69 m ³)	3.032	4.568	2.616	18.288	2.608	6.904	5.424
Adet / pcs in TRUCK OPTIMA (78,5 m ³)	3.448	5.192	2.976	20.808	2.964	7.856	6.168
Barkod / EAN code*	 8 691311 000111	 8 691311 000128	 8 691311 000135	 8 691311 061112	 8 691311 200016	 3 321361 150027	 8 691311 515226







Ürün Kodu / Product Code	PL.03	PL.04	PL.05	PL.06	PM.01	PM.02	PO.05
Sayfa / Page	57	58	58	58	44	45	31
En (Width) mm	140	140	140	140	300	300	230
Boy (Lentgh) mm	315	315	315	315	405	405	480
Yükseklik (High) mm	325	385	445	565	140	155	230
Koli İçi Adeti (pcs/per box)	8	4	4	4	12	12	9
Koli Hacmi (volume per box m ³)	0,125	0,072	0,086	0,108	0,221	0,233	0,211
Adet / pcs in 20" (28,5 m ³)	1.824	1.572	1.328	1.060	1.536	1.464	1.215
Adet / pcs in 40" DC (61 m ³)	3.904	3.368	2.844	2.268	3.300	3.132	2.601
Adet / pcs in 40" HC (69 m ³)	4.416	3.808	3.216	2.564	3.744	3.588 ***	2.925 ***
Adet / pcs in TRUCK OPTIMA (78,5 m ³)	5.024	4.332	3.660	2.920	4.260	4.032	3.348
Barkod / EAN code*	 3 321361 150010	 8 691311 515295	 3 321361 150003	 8 691311 515271	 8 691311 061167	 8 691311 061150	 8 691311 493029









PORT-BAG®

ÜRÜN BİLGİLERİ PRODUCT DATA

* Barkod numaraları ürün renklerine göre değişebilmektedir.
Ean number are different according to product colours
** Yükleme adetleri tahminidir / These figures are estimated quantities
*** Kesin adetlerdir / These figures are exact quantities

Ürün Kodu / Product Code	PO.06	PO.07	PO.08	PO.09	PO.09 M	PO.10 M	PP.01
Sayfa / Page	29	30	32	33	42	41	67
En (Width) mm	150	200	290	340	340	270	265
Boy (Lentgh) mm	320	410	555	600	600	450	320
Yükseklik (High) mm	135	180	265	320	320	585	50
Koli İçi Adeti (pcs/per box)	12	12	6	1	1	1	18
Koli Hacmi (volume per box m ³)	0,078	0,170	0,249	0,073	0,079	0,078	0,077
Adet / pcs in 20" (28,5 m ³)	4.404	2.160 ***	684	389	360	365	6.678
Adet / pcs in 40" DC (61 m ³)	9.432	4.308	1.464	833	772	782	14.310
Adet / pcs in 40" HC (69 m ³)	10.668	4.884	1.728 ***	942	873	884	16.182
Adet / pcs in TRUCK OPTIMA (78,5 m ³)	12.144	5.556	1.890	1.072	993	1.006	18.414
Barkod / EAN code*	 8 691311 494941	 8 691311 487639	 8 691311 352050	 8 691311 981250	 8 691311 763481	 8 691311 918478	 3 321369 942013







Ürün Kodu / Product Code	PP.02	PP.03	PP.04	PP.05	PP.08	PR.05	PR.07
Sayfa / Page	67	68	69	69	70	39	38
En (Width) mm	300	375	255	370	279	250	210
Boy (Lentgh) mm	380	480	300	400	322	495	440
Yükseklik (High) mm	60	75	54	58	297	230	195
Koli İçi Adeti (pcs/per box)	16	10	18	12	1	6	12
Koli Hacmi (volume per box m ³)	0,119	0,135	0,081	0,107	0,029	0,158	0,196
Adet / pcs in 20" (28,5 m ³)	3.824	2.110	6.282	3.180	979	1.080	1.740
Adet / pcs in 40" DC (61 m ³)	8.192	4.510	13.464	6.804	2.096	2.316	3.720
Adet / pcs in 40" HC (69 m ³)	9.264	5.110	15.246	7.704	2.370	2.622	4.212
Adet / pcs in TRUCK OPTIMA (78,5 m ³)	10.544	5.810	17.334	8.760	2.697	2.982	4.788
Barkod / EAN code*	 3 321369 942020	 3 321369 942037	 8 412524 021690	 8 412524 021713	 8 691311 071104	 8 691311 253012	 8 691311 131112









PORT-BAG®

ÜRÜN BİLGİLERİ PRODUCT DATA

* Barkod numaraları ürün renklerine göre değişebilmektedir.
Ean number are different according to product colours
** Yükleme adetleri tahminidir / These figures are estimated quantities
*** Kesin adetlerdir / These figures are exact quantities

Ürün Kodu / Product Code	PS.05	PS.06	PS.07	PS.08	PV.01	SA.02	SA.03
Sayfa / Page	36	35	35	36	46	51	51
En (Width) mm	230	150	210	290	330	100	154
Boy (Lentgh) mm	480	320	410	555	440	163	233
Yükseklik (High) mm	220	135	175	265	190	82	125
Koli İçi Adeti (pcs/per box)	9	12	12	6	8	16	12
Koli Hacmi (volume per box m ³)	0,212	0,078	0,170	0,245	0,244	0,020	0,046
Adet / pcs in 20" (28,5 m ³)	1.206	4.368	2.004	696	928	23.088	7.368
Adet / pcs in 40" DC (61 m ³)	2.583	9.348	4.308	1.488	2.000	49.440	15.792
Adet / pcs in 40" HC (69 m ³)	2.925	10.572	4.872	1.686	2.320 ***	55.920	17.856
Adet / pcs in TRUCK OPTIMA (78,5 m ³)	3.330	12.036	5.544	1.920	2.772 ***	63.616	20.316
Barkod / EAN code*	 8 691311 493036	 8 691311 494958	 8 691311 487646	 8 691311 453894	 8 691311 002481	 3 321360 087492	 3 321360 087560







Ürün Kodu / Product Code	SA.04	SA.04 L	SA.05	SAS.01	SAS.02	SAS.03	SM.01
Sayfa / Page	51	51	51	54	54	54	16
En (Width) mm	211	260	319	82	165	230	210
Boy (Lentgh) mm	332	419	502	515	455	515	395
Yükseklik (High) mm	174	165	199	52	82	125	177
Koli İçi Adeti (pcs/per box)	8	6	6	32	10	6	12
Koli Hacmi (volume per box m ³)	0,081	0,089	0,161	0,083	0,076	0,097	0,177
Adet / pcs in 20" (28,5 m ³)	2.824	1.908	1.062	10.976	3.740	1.758	1.932
Adet / pcs in 40" DC (61 m ³)	6.056	4.092	2.274	23.552	8.000	3.768	4.128
Adet / pcs in 40" HC (69 m ³)	6.848	4.632	2.574	26.624	9.050	4.260	4.680
Adet / pcs in TRUCK OPTIMA (78,5 m ³)	7.792	5.268	2.928	30.304	10.300	4.848	5.316
Barkod / EAN code*	 3 321360 087638	 3 321360 087706	 3 321360 087874	 8 691311 771134	 8 691311 805358	 8 691311 866816	 8 691311 951161







PORT-BAG®

ÜRÜN BİLGİLERİ PRODUCT DATA

* Barkod numaraları ürün renklerine göre değişebilmektedir.
Ean number are different according to product colours
** Yükleme adetleri tahminidir / These figures are estimated quantities
*** Kesin adetlerdir / These figures are exact quantities

Ürün Kodu / Product Code	SM.02	SM.03	SP.01	SP.02	SP.03	TA.02	TA.03
Sayfa / Page	17	18	13	14	15	53	53
En (Width) mm	233	276	210	233	276	160	230
Boy (Lentgh) mm	458	535	395	458	535	100	140
Yükseklik (High) mm	247	267	177	247	267	70	125
Koli İçi Adeti (pcs/per box)	9	6	12	9	6	36	24
Koli Hacmi (volume per box m ³)	0,235	0,241	0,177	0,235	0,242	0,041	0,100
Adet / pcs in 20" (28,5 m ³)	1.089	708	1.932	1.089	702	24.768	6.864
Adet / pcs in 40" DC (61 m ³)	2.331	1.518	4.128	2.331	1.506	53.028	14.688
Adet / pcs in 40" HC (69 m ³)	2.637	1.716	4.680	2.637	1.710	60.012	16.608
Adet / pcs in TRUCK OPTIMA (78,5 m ³)	3.006	1.950	5.316	3.006	1.944	68.256	18.888
Barkod / EAN code*	 8 691311 951185	 8 691311 951215	 8 691311 950164	 8 691311 950188	 8 691311 950218	 3 321360 001207	 3 321360 001214

Ürün Kodu / Product Code	TA.04	TA.05	TK.50	TK.70	TK.100		
Sayfa / Page	53	53	47	48	49		
En (Width) mm	330	460	220	270	350		
Boy (Lentgh) mm	200	305	225	330	500		
Yükseklik (High) mm	150	175	72	80	110		
Koli İçi Adeti (pcs/per box)	12	4	8	6	5		
Koli Hacmi (volume per box m ³)	0,113	0,089	0,033	0,050	0,119		
Adet / pcs in 20" (28,5 m ³)	3.012	1.284	7.000	3.438	1.190		
Adet / pcs in 40" DC (61 m ³)	6.456	2.748	14.984	7.368	2.550		
Adet / pcs in 40" HC (69 m ³)	7.308	3.112	16.952	8.334	2.885		
Adet / pcs in TRUCK OPTIMA (78,5 m ³)	8.316	3.540	19.280	9.480	3.285		
Barkod / EAN code*	 3 321360 001221	 3 321360 001238	 3 321369 987274	 3 321369 986192	 3 321369 987298		