

# Specialists in DIAMOND Tools



**ABRASIVOS  
GRINDING**



**CATALOGUE\_2018**

# GENERAL INDEX

DISC  
RANGE

 **PLATINUM**  
 **PROFESSIONAL**  
 **BASIC**

☆☆☆☆☆  
 ☆☆☆☆  
 ☆☆☆

**DISCS  
FOR ANGLE  
GRINDERS.**











































**BLADES FOR CERAMICS,  
CUTTING TABLES AND  
GASOLINE CUTTERS.**



**BLADES  
FOR JOINT  
CUTTING.**



	PLATINUM	PROFESSIONAL	BASIC					
General of Construction	 Huracán	 Láser PRO	 Fórmula Intercooler	 Universal Básico	 Ladrillo Caravista	 Láser PRO	 Universal Básico	
	 Tornado			 Fórmula				
		 Vulcan				 Deep		
			 Turbo PRO	 Turbo Básico		 Láser Turbo		
Ceramic Tiles	 Turbo Extrafino Platinum	 Porcelanato Segmentado	 Porcelanato Banda Continua	 Cerámica Banda Continua	 Porcela.Seg. PREMIUM	 Porcelanato Banda Continua	 Cerámica Banda Continua	
		 Turbo Extrafino Pro			 Turbo Extrafino			
Granite and hard materials	 Cantero	 Láser Granito			 Granito			
		 Láser Arce Gr.						
		 Turbo Huracán	 Turbo Plus					
CONCRETE		 Láser Hormigón			 Deep	 Hormigón Alto rendimiento	 Pavimento	 Hor.curado Stándard
						 Asfalto	 Pavimento	 Hor.fresco Stándard
Marble		 Mármol		 Mármol				
Metal construction and materials		 Corta todo			 Metal Cutting			

# HOW TO SELECT YOUR DIAMOND DISC?

## 1 MACHINE TO BE USED

The machine will determine the diameter of the disc, the inner and the drag holes (if necessary).

For use in the stone industry or in the concrete cutting (walls / floors), it is important to know the power of the machine, revolutions to which the disk rotates, speed of advance and depth of cut.

## 2

MATERIALS TO BE CUT	DISC TO CHOOSE	TECHNICAL FEATURES OF THE DISC
HARD AND COMPACT MATERIALS	<b>GRANITO</b>	Diamond powder: Thick grain and high hardness to achieve high cutting capacity. Metal Alloy: Medium or low hardness
GENERAL CONSTRUCTION MATERIALS	<b>GENERAL DE OBRA</b>	Diamond powder: Medium grain and high concentration of high hardness diamond to achieve high performance. Metal alloy: High resistance to wear that is achieved by adding hardeners.
CONCRETE AND ABRASIVE MATERIALS	<b>HORMIGÓN</b>	Diamond powder: Medium grain and medium hardness Metal Alloy: Medium hardness.
CERAMIC MATERIALS	<b>TURBO EXTRAFINO PORCELANTO SEGMENTADO BANDA CONTINUA</b>	Diamond powder: Fine grain for a better cutting finish. Metal Alloy: Soft.

## 3

PRICE	DISCS RANGE	TECHNICAL FEATURES
ECONOMIC	<b>BASIC</b>	Cold pressed disc. Low level of hardness and density of the segment, which determines a low performance of the disk.
MEDIUM	<b>PRO</b>	Hot-pressed or segment-made disk made by volumetric press and subsequently welded by laser welding, high performance and good cutting capacity for each of the recommended materials.
HIGH	<b>PLATINUM</b>	Hot-pressed or segment-made disk made of volumetric press and subsequently welded by laser welding. Optimum performance and cutting capacity in all types of building materials.

As far as the price level of the disk changes, the quality and concentration of the diamond increases, allowing the use of metallic powders of greater hardness and density, obtaining a greater duration and cutting speed of the disc.

In Platinum discs the cutting speed and performance in the different materials used in the construction is optimal.

## ELECTRODEPOSITADO Y CORTA TODO

Diamond powder is increasingly being used in cutting, grinding and polishing tools for different types of materials. With different processes of fixing the diamond to the steel blade.

For the cutting of marble and limestone, the electroplated disc is recommended, in which the diamond powder is fixed to the steel blade by the **ELECTROLYSIS** technique.

The disc **CORTA TODO** has the diamond powder fixed on the edge of the steel blade, using a technique called **VACUUM BRAZING** that is performed in a vacuum oven and allows a higher adhesion than in the electroplated disc. Normally a very high diamond hardness is used, which allows the cutting of iron, metal profiles and practically all materials used in construction.

# NEW PACKAGING TO FACILITATE YOUR CHOICE OF THE CORRECT DISC



**PLATINUM** | Turbo Extrafino Platinum  
Tornado Platinum  
Láser Huracán  
Huracán Silencioso  
Cantero



**PROFESSIONAL** | Láser Profesional  
Láser Granito  
Láser Hormigón  
Fórmula Intercóoler  
Turbo Profesional  
Turbo Extrafino porcelanato  
Mármol Electrodepositado



**BASIC** | Universal Básico  
Turbo Básico  
Cerámica Banda Continua  
Fórmula

“ Each package contains a full description of all the discs of the range and its main feature, and includes a sticker showing the appropriate applications of the disc. ”

# BLADES FOR: CONSTRUCTION ANGLE GRINDERS AND CHOP SAWS

CERAMIC TILES



## ○ PORCELÁNICO TURBO EXTRAFINO PLATINUM

Ø mm	h	Bar code 8427648	Item Code
115	7	676947	14.18
115 R	7	684911	14.239
125 R	7	676350	14.240
150 R	7	696068	1500.77
180 R	7	697461	1500.104
200 R	7	702905	1500.128
230 R	7	723313	8294.17
250 R	7	693098	1500.1
300 R	7	694477	1500.2

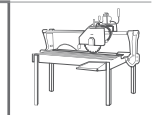

- Ideal for **porcelain and ceramic tiles**.  
Also for hard materials such as granite, stoneware or klinker.
- The metal alloy contains a fine, **high quality diamond grain** that provides a lower material cracking and a **better finish on surfaces**.
- The **extra thin**, continuous and crenelated diamond crown allows a perfect finish.
- The steel blade is 0.85 mm thick in 115 mm diameter discs and contains a welded flange of 5cm Ø that provides rigidity and eliminates warping.



## ○ SUPER TURBO EXTRAFINO PORCELANATO

Ø mm	h	Bar code 8427648	Item Code
115	10	703247	14.353
125	10	706101	14.394

- The best finishing in the cut of porcelain, stoneware and **ceramic materials in general**.  
Continuous and crenelated diamond crown.
- The steel blade, the **extra-fine crown and the high quality** of the metal alloy allows a perfect finish.
- The diamond crown of **10mm height allows** a high performance.





## HURACÁN



## HURACÁN SILENCIOSO



**GREAT NOISE REDUCTION:**  
 STANDARD Model: 101dB [A].  
 SILENT Model: 85 dB [A].

### ○ HURACÁN

Ø mm	h	Bar Code 8427648	Item Code
115	10	686533	14.241
125	10	704602	14.375
230	10	704985	100.1165

- High quality diamond disc for, **high abrasiveness / hardness**, construction materials cutting: **cement, concrete with or without rod, brick, granite, klinker, natural and artificial stone.**
- **Castled segment** for a **greater speed** at the beginning of cutting.
- **Cooled steel core.**
- Diamond powders with titanium coating are used to get a higher adherence of the diamond grain to the metal alloy and a fast cutting in materials of extreme hardness is guaranteed.
- Laser welded segments.



### ○ HURACÁN **SILENCIOSO**

Ø mm	h	Bar Code 8427648	Item Code
230	12	720282	100.1771

- High quality diamond disc for, **high abrasiveness / hardness**, construction materials cutting: **cement, concrete with or without rod, brick, granite, klinker, natural and artificial stone.**
- **12 mm segment height** for a longer durability.
- **Cooled steel core.**
- **Special silent blade**, 50 % noise reduction.
- Laser welded segments.





## ADVANCED TECHNOLOGY

**For all types of materials of extreme hardness.** Segment formed by 15 layers (7 of diamond + 8 powder).

The positioning of the diamond ensures the stability of the product.

It is the most technologically advanced disk on the market. DIAMONDS positioned and distributed on a homogeneous way. Segment formed by 15 layers (8 of powder, 7 of diamond).

### PRODUCTION METHOD

The diamond grains are positioned in the segment in an orderly way and at a regular distance from each other, which makes the disc highly efficient.

### DIAMOND POSITIONING

The orderly and regular positioning of the diamond grains improves the cut and increases the durability of the disc.

### ADVANTAGES

- Better capacity and speed of cutting.
- Excellent finishing cuts.
- Increases the disc's durability by approximately 40%.
- Reduces power consumption
- Suitable for all types of material including those of maximum hardness.
- Lower vibration.

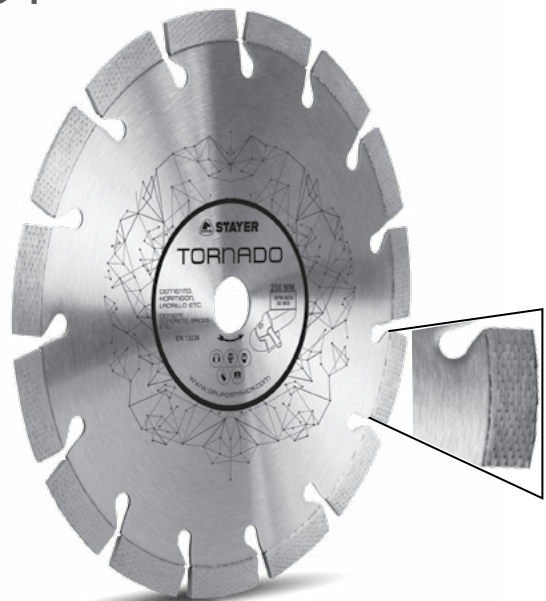

## ○ TORNADO

Ø mm	h	Bar Code <b>8427648</b>	Item Code
115	12	709706	14.416
125	12	709713	14.417
230	12	702547	14.338

- High quality disc for building materials cutting: cement, concrete with or without rod, bricks, etc.. even for materials of extreme hardness such as granite, klinker, natural and artificial stone.
- 12 mm segment height for a longer durability.
- Perfect Diamond **positioning** to **optimize the cutting capacity and performance.**
- Reinforced blade and segments.

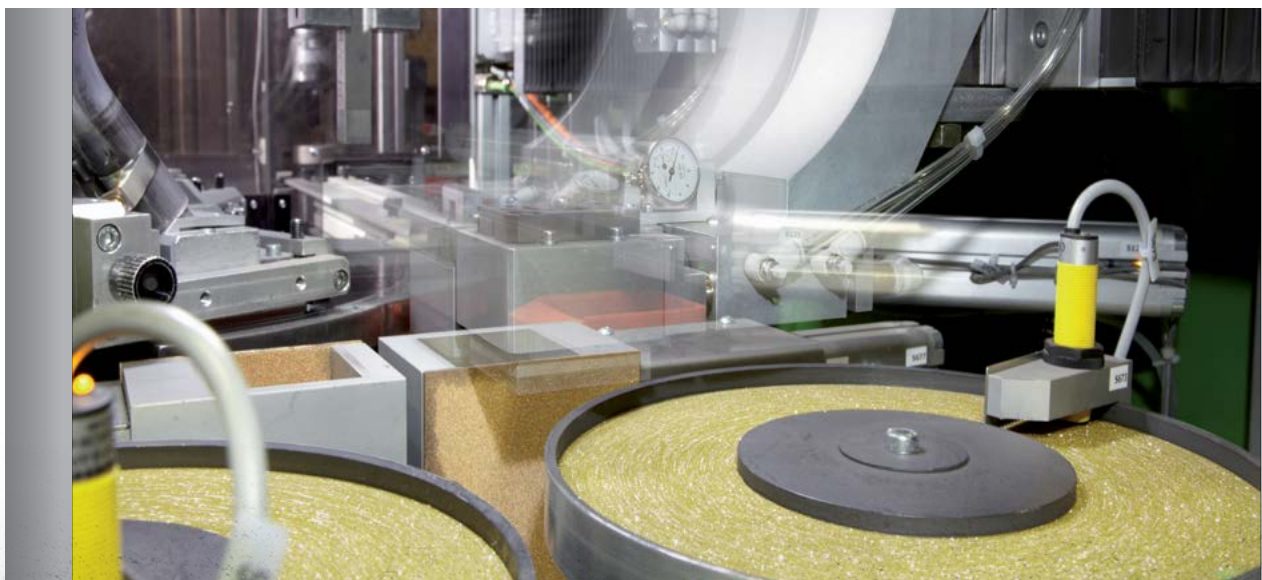
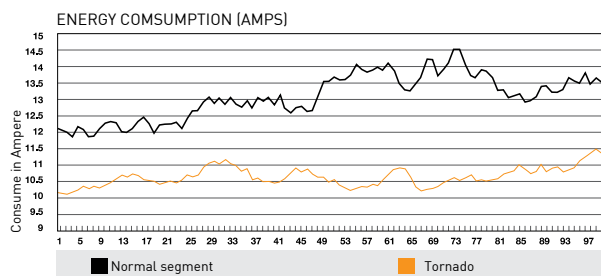



DISCS FOR  
STONE

SPECIAL DISC FOR  
QUARRY WORKS.



CANTERO  
GRS50

## CANTERO

DIFFERENT HARDNESSES AVAILABLE FOR Ø 230 MM

Ø mm	h	Bar Code 8427648	Item Code
115	12	724884	8299.23
125	12	724082	8299.13
180	12	724785	8299.21
230 G40	12	723191	8299.2
230 GRS50	12	716599	100.1531
230 GRS60	12	718159	100.1628

### CANTERO GRS40

- Fast cutting of granites of **different hardness**.

### CANTERO GRS50

- Designed for **hard granites**. High speed cutting disc.

### CANTERO GRS60

- High-quality disc for **water cutting**.



## ISO CERTIFICATE

### ISO 9001:2008

This international standard is a requirement for the certification of a quality management system. Abrasivos Grinding, also a Stayer Group company as Oscar Diamant, has obtained the quality certification for product development, laboratory analysis, product control, purchasing, sales, etc.

### ISO 14001:2004

This standard sets the criteria of a production with a low environmental impact. Abrasivos Grinding has been certified for developing a productive process that takes into consideration the environmental protection ensuring the total absence of contaminants at the various stages of the production of diamond blades.



## BLADES FOR ANGLE GRINDERS



TECHNICAL DATA  
MAXIMUM  
DEPTH AND  
CUTTING SPEED

		R.P.M. recommended	R.P.M. maximum
100mm/4"	25mm/1"	9000	13000
115mm/4,5"	30mm/1,25"	8000	13300
125mm/5"	35mm/1,5"	7300	12000
180mm/7"	65mm/2,5"	5200	8800
200mm/8"	70mm/3"	5200	8800
230mm/9"	83mm/3,25"	4500	7800



# BLADES AND DIAMOND TOOLS



## ROUGHING BLADES

ALUMINUM SEGMENTS BLADE



For natural stone (granite and marble).  
GRC 30-40 High roughing capacity.  
GRM 40-50, high performance.

Axis			
100 GRM 30	M14	8299.1	
100 GRM 40	M14	8299.16	
125 SPEED	M14	8299.8	

DOUBLE SEGMENT BLADE



For concrete and stone sanding.

Axis			
100*	M14	8294.41	
125*	M14	14.30	
180*	M14	8294.65	
100 sinterizado	22.23	8294.45	

\* Silver welding

EPOXY PLATE VC



Ideal for removing all types of coatings, glue, epoxy, fiberglass, paint etc.

Not suitable for concrete tearing.

Axis		
125	22.23	14.446

## DIAMOND TOOLS

### LAGGED & REINFORCED CONCAVE DISC FOR GRANITE



Ø mm	h	Bar Code 8427648	Item Code
125	7	676459	14.40
180	7	676039	14.64
180	7	681330	14.183

- Curved cutting of natural stone countertops.

## TECHNICAL INFORMATION



### TENSION

The lack of tension reduces the force of the disc's core, allowing the disc to rotate unevenly at the recommended speed.

**1. Cause:** : The disc has a twisted shaft.

**Remedy:** Check that the shaft is aligned.

**2. Cause:** Disc core overloaded.

**Remedy:** On wet cutting, provide the adequate amount of water on both sides of the disc. On dry cutting, let the disc spins on no load for a few minutes, to get refrigerated.

**3. Cause:** The disc runs at higher R.P.M.

**Remedy:** Inspect any damage that may have occurred on the shaft. Tighten the nut and make sure the mechanism is working properly. If the disc has a dark blue colour, it may be because it is getting deformed.



### LOSS OF CUTTING POWER

**Cause:** The disc does not self-rectify sufficiently on the material being used.

**Remedy:** Make cuts on some sandstone abrasive material, prefabricated concrete, cement.

It is recommended to use sharpening stones to recover the cutting capacity.



### BREAKDOWN OF THE SEGMENT

**1. Cause:** The diamond chip is too hard for the material to be cut.

**Remedy:** Use a disc with a softer alloy.



### EXCESSIVE DISC WEAR OUT

**1. Cause:** Disc core wears out faster than the diamond segment, especially in areas where both are joined.

**Remedy:** Use a disc with a softer alloy.

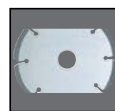

### DESCENTRATED EYEHOLE

**1. Cause:** The flanges are not properly tensioned, causing the disc to rotate or vibrate on the shaft.

**Remedy:** Fasten the disc.

**2. Cause:** : The shaft is defective because the disc has been misplaced.

**Remedy:** Make sure that the disc is properly seated before tightening the nut.

On concrete discs make sure that the bolt is properly engaged over the drive hole.



### SEGMENT LOSS

Do not use the disc with the lack of any segment.

**Cause:** Overheating accompanied by a bluish colour in the area of the disc where the segment is missing.

**Remedy:** On wet cutting, provide adequate amount of water on both sides of the disc.

On dry cutting, let the disc spins on no load for a few minutes, to get refrigerated.

**Cause:** Either the material to be cut or the disc are not secured, causing the disk to jam and miss the segment.

**Remedy:** Hold the material or disc firmly.

**Cause:** Not proper cuttings in a straight line, which causes the disc to jam and then lose the segment.

**Remedy:** Make a tight cut in a straight line. Avoid twisting when cutting.

**Cause:** The disc fastening flanges are not properly supported.

**Remedy:** Clean the surface of the disc.

**Cause:** The disc is too hard for the material to be cut, causing excessive jams and the segment ends up separating due to the blows (this can also be caused by the heat, which can melt the copper welding).

**Remedy:** Change shaft of fixings flanges.

# BLADES FOR: CONSTRUCTION ANGLE GRINDERS AND CHOP SAWS



## ○ LÁSER PROFESIONAL

GENERAL CONSTRUCTION USE

Ø mm	h	Bar code <b>8427648</b>	Item code
115	7	723221	8299.5
125	7	724679	8299.19
180	7	694842	1500.28
230	7	724044	8299.9
115	10	724778	8299.20
125	10	723214	8299.4
230	10	723207	8299.3
250	7	702660	1500.122
300	7	702677	1500.123
300	10	702684	1500.124
350	7	702691	1500.125
350	10	672369	100.39

- All types of **building materials**: low hardness, medium hardness and medium-high. **Bricks, concrete blocks, Ceramic tiles** ...
- Laser welded segments.

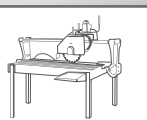

## ○ LÁSER GRANITO

Ø mm	h	Bar Code <b>8427648</b>	Item Code
115	7	724655	8299.17
125	7	724822	8299.22
180	7	703735	22.13
230	7	724068	8299.11

- General purposes in **granite and hard materials works**.
- Laser welded segments



## ○ LÁSER HORMIGÓN

Ø mm	h	bar Code <b>8427648</b>	Item Code
115	7	694910	1500.35
125	7	694927	1500.36
150	7	694934	1500.37
180	7	695177	1500.45
230	7	694941	1500.38
115	10	697737	1500.108
125	10	703926	1500.139
230	10	697744	1500.109

- For concrete, **cement and abrasive materials cutting**.
- Laser welded segments.



# BLADES FOR: CONSTRUCTION ANGLE GRINDERS AND CHOP SAWS



## ○ CONSTRUCCIÓN LD INTERCOOLER VULCAN

GENERAL CONSTRUCTION USE

Ø mm	h	Bar Code 8427648	Item Code
115	10	724099	8299.14
125	10	703056	1500.132
230	10	724105	8299.15

- All types of construction materials of low, medium and medium-high hardness. **Cement, terrazzo, refractories, etc.**
- 10mm segment height for a greater performance.
- Laser Welded segments
- Cooled steel core that allows longer continuous cutting.



## ○ ARCE GRANITO

Ø mm	h	Bar Code 8427648	Item Code
115	10	676909	14.347
125	10	676534	14.346
150	10	688049	14.424
180	10	676107	14.348
230	10	675940	14.329

- Cutting of **granite and hard materials** at high speed.
- **Crenelated segment** for greater cutting capacity.
- Laser welded segments.



## ○ FÓRMULA INTERCOOLER H12

GENERAL CONSTRUCTION USE

Ø mm	h	Bar Code 8427648	Item Code
115	12	724112	8294.42
125	12	724648	8294.52
180	12	704701	14.381
230	12	702530	8294.51

- All types of construction materials of low, medium and medium-high hardness.
- 12 mm segment height, to achieve greater performance.
- Cooled steel core
- Crenelated segment for a better cut.



## BLADES FOR: CONSTRUCTION ANGLE GRINDERS AND CHOP SAWS



### TURBO PROFESIONAL

GENERAL CONSTRUCTION USE

Ø mm	h	Bar Code 8427648	Item Code
115	7	722965	8294.5
125	7	723627	8294.38
180	7	723634	8294.39
230	7	722972	8294.6

- General purposes for **construction materials** of medium and medium-high hardness.
- Crenelated crown with continuous and wide turbo segments for a better cutting finish.



### TURBO HURACÁN

Ø mm	h	Bar Code 8427648	Item Code
115	10	694392	14.301
125	10	694408	14.302
230	12	694422	14.304

- High quality diamond disc for **construction materials** including high hardness. **Granite, Klinker, artificial stone, porcelain, stoneware, ...**
- Continuous turbo segment a for better cutting finish.
- **12 mm segment height** for better performance.
- **Cooled steel core** that allows longer continuous cutting time.



### TURBO PLUS REFORZADO (LÁGRIMAS)

Ø mm	h	Bar Code 8427648	Item Code
115	8	676923	14.20
125	8	676497	14.36
150 LÁGRIMA	10	703087	14.350
180	8	676053	14.62
230	8	675506	14.93

- **Diamond reinforcements** that allow **deeper cuts** with better cooling, a tighter cut and **higher throughput**.
- Continuous turbo segment for a better cutting finish.
- Reinforced blade for greater resistance to torsion



# BLADES FOR: CONSTRUCTION ANGLE GRINDERS AND CHOP SAWS



## TURBO EXTRAFINO PROFESIONAL

Ø mm	h	Bar Code 8427648	Item Code
115 R	7	722958	8294.4
125 R	7	723320	8294.18
230 R	7	723337	8294.19

- Suitable for porcelain, **ceramic tiles**, ....  
Also for hard materials such as granite, stoneware or klinker.
- The metal alloy contains a fine, **high quality diamond** grain that provides a lower material cracking and a better finish on surfaces.
- The **extra thin**, continuous and crenelated diamond crown allows a perfect finish.
- The steel blade is 0.85 mm thick in 115 mm diameter discs and contains a welded **flange of 5cm Ø** that provides rigidity and eliminates warping.

☆☆☆☆

## PORCELANATO SEGMENTADO

Ø mm	h	Bar Code 8427648	Item Code
115	7	724594	8294.47
125	7	695894	1500.68
180	7	702912	1500.129
200	7	702929	1500.130
230	7	725751	8294.67
250	10	693968	1500.12
300	7	694453	1500.20
350	7	696143	1500.21

- For cutting **porcelain, vitrified ceramic**, marble and artificial stones.
- Nearly continuous "J" shaped rim for a **better cut finish**.

☆☆☆☆

				Inside diameter
300 PREMIUM	7	680005	14.158	25.4
300 PREMIUM	7	713673	14.435	60
350 PREMIUM	7	680012	14.159	25.4
350 PREMIUM	7	709942	14.423	60
400 PREMIUM	7	680791	14.175	60

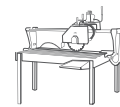

## PORCELANATO BANDA CONTINUA

Ø mm	h	Bar Code 8427648	Item Code
115	8	724617	8294.49
230	8	696105	1500.81
300	7	695740	1500.54
350	7	693517	1500.6

- For cutting **porcelain, vitrified ceramic**, marble and artificial stones.
- **Continuous rim** for a better cutting finish.

☆☆☆☆

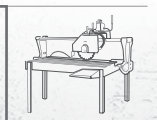

## BLADES FOR: **CONSTRUCTION ANGLE GRINDER, CHOP SAW AND HAND HELD**



### ○ MÁRMOL **ELECTRODEPOSITADO**

Ø mm	Bar Code <b>8427648</b>	Item Code
115	725898	8299.26
125	725904	8299.27
180	690141	36.41
230	726031	8110.30
230 CF	726048	8110.31

- Special blade for cutting **limestone and marble**.
- **Blade protective reinforcement.**



### ○ CORTA **TODO**

Ø mm	Bar Code <b>8427648</b>	Item Code
115	707160	40.22
125	707900	40.30
230	707269	40.24

- **Vacuum Brazing technology**
- Cut all types of materials **iron, metal profiles, concrete, pvc, granite, marble, stone, brick, tile**, etc.
- **Segmented for a faster cutting.**



### ○ METAL **CUTTING**

Ø mm	Ø Int.	Bar Code <b>8427648</b>	Item Code
300	25,4	703070	14.349

- **Ferrous materials** (beams, sheet metal, metal profiles ...)
- And all kinds of **building materials**: marble, granite, slate, porcelain, stoneware, ferrogres, klinker ...

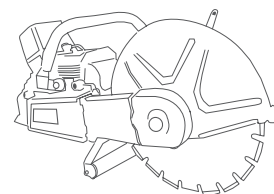

### ○ CONSTRUCTION MATERIAL **GRINDING**



Ø mm		Bar Code <b>8427648</b>	Item Code
180	24 GR GRUESO	692046	10.6

- **Grinding, construction materials and stone.**



## QUALITY CONTROL TECHNICAL INFORMATION

☆ Top quality - High diamond concentration.

VARIABLES	ESTADO	CUTTING SPEED	TOOL'S LIFE
Diamond hardness	Harder Softer	Slower Faster	More Less
Diamond quality	Lower Higher	Slower Faster	Less More
Diamond size	Bigger Smaller	Faster Slower	Less More
Diamond concentration	Less More	Faster Slower	Less More
Segment thickness	Less More	Faster Slower	Less More
Power of machine	Less More	Slower Faster	More Less
Periferic speed	Less More	Faster Slower	Less More
Water flow	Less More	Faster Slower	Less More
Cutting depth	Less More	Faster Slower	More Less
Abrasion	More Less	Faster Slower	Less More
Solid size	Bigger Smaller	Less Less	More Less
Steel armor reinforced	Less More	Faster Slower	More Less



BASIC

# BLADES FOR: CONSTRUCTION ANGLE GRINDERS AND CHOP SAWS



## ○ UNIVERSAL **BÁSICO**

Ø mm	h	Bar Code <b>8427648</b>	Item Code
115	7	722941	8294.3
125	7	723412	8294.23
180	7	723597	8294.37
230	7	723115	8294.9
300	10	695320	1500.49
360	10	692916	36.52

- General purposes for construction materials of low and medium-low hardness.



## ○ TURBO **BÁSICO**

Ø mm	h	Bar Code <b>8427648</b>	Item Code
115	7	722668	8294.1
125	7	723573	8294.35
180	7	723580	8294.36
230	7	722675	8294.2

- General purposes for construction materials of low and medium-low hardness.

- Continuous turbo segment for a better cutting finish.



## ○ CERÁMICA **BANDA CONTINUA**

Ø mm	h	Bar Code <b>8427648</b>	Item Code
115	7	724266	8294.44
125	7	724839	8294.55
150	7	676244	36.10
180	7	724808	8294.53
200	7	724846	8294.56
230	7	724853	8294.57
250	7	724815	8294.54
300	7	724860	8294.58
350	7	690097	36.38

- For ceramic tiles of low and medium hardness.

- Continuous band for better cutting finish.





# BLADES FOR: ANGLE GRINDER AND CONSTRUCTION CHOP SAW



## ○ FÓRMULA H10

Ø mm	h	Bar Code 8427648	Item Code
115	10	723344	8294.20
125	10	725171	8294.63
230	10	723351	8294.21

- General purposes of work and granite.
- Crenelated segment that provides faster cutting speed.



## SPECIAL BLISTERS

Blade Ø 115 mm

Ø 115 mm disc

A - Continuous Band + Turbo + Segmented

B - Cortado + 3 abrasive discs 115x1.0

C - Turbo Extrafino Porcelanato + Universal.

D - 2 turbo Extrafino + quick lock nut



Cod. 36.87



Cod. 40.27



Cod. 40.31



Cod. 5.888

# MANUFACTURING PROCESS OF **DIAMOND BLADES**





1. **PREPARATION OF POWDER:** MISTURES AND GRANULATORING. METAL POWDER + DIAMONT POWDER
2. **PRESS:** GRAVIMETRIC COLD PRESS OR VOLUMETRIC COLD PRESS. POSSIBILITY TO POSITION THE DIAMOND.
3. **VACUUM SINTERING PRESS WITH AUTOMATIC CHARGERS.**
4. **DRAZING WELDING AND LASER WELDING.**
5. **RECTIFYING AND TENSIONING.**
6. **LASER MARKING AND PAINTING.**



REQUEST  
YOUR VISIT AT   
**902 91 86 81**

[www.stayer.es](http://www.stayer.es)

**WOULD YOU LIKE  
TO KNOW HOW IS  
MANUFACTURED THE  
DIAMOND DISC**

*YOU ARE INVITED!*

# BLADES FOR: **CHOP SAW, GASOLIN HAND HELD AND FLOOR SAWS**

## BLADES FOR TABLE SAW MACHINE AND HAND HELD

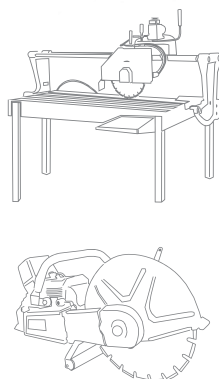
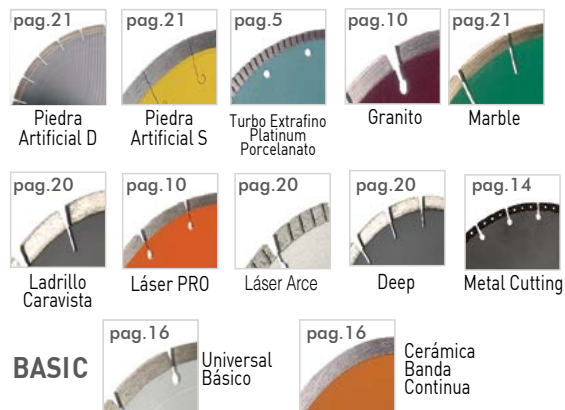

## BLADES FOR FLOOR SAWS

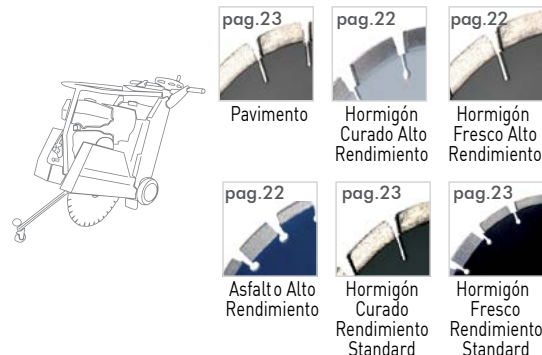

WE MAKE DISCS FROM: Ø300mm to Ø3500mm

## CONSTRUCTION BLADES



### DEEP H10

Ø mm	h	Bar Code 8427648	Item Code
300	10	714779	100.1413
350	10	714786	100.1414
400	10	714793	100.1415

- Suitable for manual gasoline cutter.
- Bricks, concrete, cement, brick, terrazzo and building materials.
- Laser welded segments.

### LÁSER ARCE CONSTRUCCIÓN

Ø mm	h	Bar Code 8427648	Item Code
300	10	698055	1500.116
350	10	702707	1500.126

- Suitable for manual gasoline cutter.
- The crenelated segments provide a greater cutting speed
- Bricks, concrete, cement, brick, terrazzo and building materials.
- Laser welded segments.

### LADRILLO CARAVISTA

Ø mm	h	Bar Code 8427648	Item Code
300	10	672499	100.26
350	10	672307	100.45

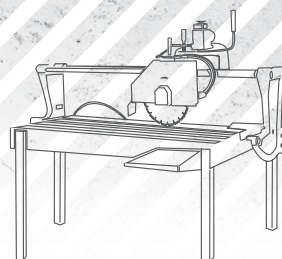

- Ideal for cutting bricks, refractory, terrazzo, cement, prefabricated concrete and abrasive materials.
- Laser welded segments.
- 10 mm height segment for greater performance.

# BLADES FOR TABLE SAW MACHINE



## TECHNICAL DATA MAXIMUM DEPTH AND CUTTING SPEED

## BLADES FOR WORK MACHINES

 Ø	 h seg	R.P.M. recommended	R.P.M. max
300mm/12"	100mm/4,5"	2900	3200
350mm/14"	125mm/5"	2600	2800
400mm/16"	150mm/6"	2200	2400

## GRANITO MÁQUINA DE MESA

Ø mm	h	Bar Code 8427648	Item Code	
300	10	686939	100.548	- Granite.
300SILENC	10	700260	100.916	
350	10	700451	100.934	
350SILENC	10	700444	100.933	

## PIEDRA ARTIFICIAL D

Ø mm	h	Bar Code 8427648	Item Code	
300	-	---	---	- Stone.
350	-	---	---	

## MÁRMOL MÁQUINA DE MESA

Ø mm	h	Bar Code 8427648	Item Code	
300	7	686946	100.549	- Marble.
350	7	700635	100.952	

## PIEDRA ARTIFICIAL S

Ø mm	h	Bar Code 8427648	Item Code	
300	-	---	---	- Stone.
350	-	---	---	

# BLADES FOR FLOOR SAWS

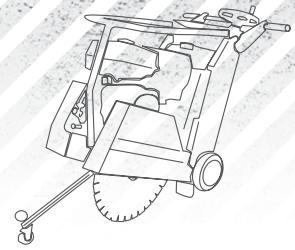

## ○ HORMIGÓN CURADO ALTO RENDIMIENTO

Ø mm	h	Bar Code <b>8427648</b>	Item Code
300	10	698062	100.847
350	10	700475	100.936
400	10	700727	100.961
450	10	700871	100.976
500	10	701014	100.990

- Old concrete.
- Old reinforced concrete.

## ○ HORMIGÓN FRESCO ALTO RENDIMIENTO

Ø mm	h	Bar Code <b>8427648</b>	Item Code
300	10	698079	100.848
350	10	700499	100.938
400	10	667143	100.199
450	10	700895	100.978
500	10	671737	100.102

- Fresh concrete. Two bonding: **S (siliceous aggregates)** and **C (calcareous aggregates)**.
- 4 reinforcement segments of H15

## ○ ASFALTO ALTO RENDIMIENTO

Ø mm	h	Bar Code <b>8427648</b>	Item Code
300	10	672529	100.23
350	10	672413	100.34
400	10	700666	100.955
450	10	671874	100.88
500	10	682979	100.369

- Asphalt over concrete. Asphalt.
- 4 Reinforcement segments H15.

### CURED CONCRETE

Concrete usually takes 48 hours to harden. The foundation process is completed and the concrete is cured.

### USE OF REINFORCEMENT METALS

To reinforce the concrete structure, steel bars (round bars), metal cable or metal netting are used. In these cases the cutting speed is lower as well as the length of the disc.

### FRESH CONCRETE

Concrete is considered to be fresh within a period ranging from 6 to 48 hours after placement on the site. During this first phase, the cementing process between sand and aggregate is not complete and therefore the concrete does not harden completely.

If the sand is not yet amalgamated and cemented this causes a greater abrasion in the diamond disc. It is usual to work on fresh concrete to create expansion joints on roads, on industrial floors or other new applications in the construction sector.

# DISCOS PARA CORTADORAS DE JUNTAS

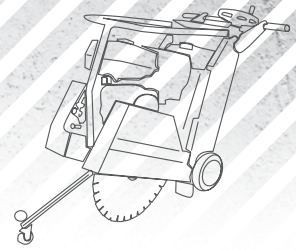

## ○ PAVIMENTO

Ø mm	h	Bar Code <b>8427648</b>	Item Code
300	10	705449	100.1183
350	10	705296	100.1169
400	10	705302	100.1170

- **Mixed disc for cured concrete and asphalt.**
- *Good performance.*
- *Reinforcement segments.*

## ○ HORMIGÓN CURADO RENDIMIENTO STANDARD

Ø mm	h	Bar Code <b>8427648</b>	Item Code
300	10	710382	1500.183
350	10	693944	1500.10

- **Old concrete**
- **Old reinforced concrete.**
- *Medium performance*

## ○ HORMIGÓN FRESCO RENDIMIENTO STANDARD

Ø mm	h	Bar Code <b>8427648</b>	Item Code
300	10	710375	1500.182
350	10	693951	1500.11

- *Fresh concrete and asphalt.*
- **Medium performance**
- *4 reinforcement segments of H15.*

### **ASPHALT**

It's a bituminous mixture that contains an 8% of oil, together with granular materials of various sizes, dust, sand and others. Asphalt, once laid, can be cut almost immediately (as soon as it cools down).

As in fresh concrete, the sand is very abrasive and causes a high disc wear out. It is recommended to use similar discs to the ones used for fresh concrete.

### **GRANULAR MATERIAL**

Granular material is the gravel that is part of the concrete in a 60% to 80% of its total composition.

It is made of natural minerals like sand, gravel and crashed stone. The different sizes and composition of these grains determines the choice of the best cutting diamond blade. If grains are big the cutting will be slower while small grains are cut faster.

## CORE DRILLS



			w seg	n° seg	Bar Code	Item Code	
20	1/2UNC	300	2,8	2	697171	1500.102	
22	1/2UNC	300	2,8	2	697034	1500.97	
24	1/2UNC	300	3	2	703223	1500.135	
32	1/2UNC	300	3	3	699540	1500.117	
36	1/2UNC	300	3	3	699632	1500.118	
25	1"1/4UNC	300	3	3	697584	1500.107	
32	1"1/4UNC	450	3	3	695771	1500.56	
36	1"1/4UNC	450	3	4	695788	1500.57	
42	1"1/4UNC	450	3,5	4	671188	100.157	
52	1"1/4UNC	450	3,5	4	671171	100.158	
62	1"1/4UNC	450	3,5	5	671164	100.159	
72	1"1/4UNC	450	4	6	671157	100.160	
82	1"1/4UNC	450	4	7	671140	100.161	
92	1"1/4UNC	450	4	8	671133	100.162	
102	1"1/4UNC	450	4	9	671126	100.163	
112	1"1/4UNC	450	4	10	671119	100.164	
122	1"1/4UNC	450	4	10	671102	100.165	
127	1"1/4UNC	450	4	10	671089	100.167	
132	1"1/4UNC	450	4	11	671072	100.168	
142	1"1/4UNC	450	4	12	671065	100.169	
152	1"1/4UNC	450	4,5	13	671058	100.170	
162	1"1/4UNC	450	4,5	14	671041	100.171	
172	1"1/4UNC	450	4,5	15	671027	100.173	
182	1"1/4UNC	450	4,5	16	690943	100.720	
202	1"1/4UNC	450	4,5	17	671010	100.174	
222	1"1/4UNC	450	4,5	18	671003	100.175	
227	1"1/4UNC	450	4,5	18	695214	100.802	
252	1"1/4UNC	450	5	18	682849	100.359	
302	1"1/4UNC	450	5	20	679344	100.251	
Ex. tube	1" 1/4 - 1" 1/4	300			697027	1500.96	
Ex. tube	1" 1/2 - 1" 1/2	300			697096	1500.99	
Adaptateurs	1" 1/4	SDS DU			696969	1500.92	

Drill bit for wet cutting.



## ○ CORTE MURAL

Ø mm	h	Bar Code 8427648	Item Code
600	10	667044	100.208
700	10	671430	100.132
800	10	671348	100.141
900	10	671232	100.152
1000	10	667051	100.207
1200	10	699755	100.867
1600	10	699946	100.886

- Mural saw.
- Normal teeth and double teeth.
- Laser welding.



## ○ CORTE HORMIGÓN (JOIST - PLATE)

Ø mm	h	Bar Code 8427648	Item Code
700	10	671423	100.133
800	10	667013	100.210
900	10	680500	100.287
1000	10	686908	100.545
1200	10	680043	100.266
1300	10	714410	100.1404

- Reinforced concrete.





BLADES FOR  
**BRIDGE SAW**



## BLADES FOR **BRIDGE SAWS**

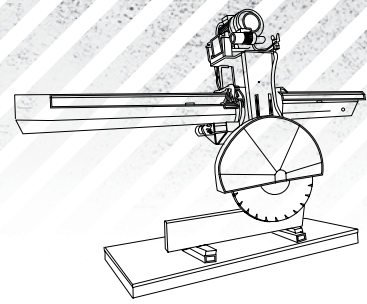

### **GRANITE CUTTING LINE. BIG BLADES**

- ▶ Our specialists will provide the perfect tool according to your needs.



DOUBLE  
TEETH



OPEN  
SLOT



CLOUSE  
SLOT



### **SPECIALISTS IN SPANISH AND PORTUGUESE GRANITES:**

- Galicia.
- Extremadura.
- Madrid - Segovia - Ávila.
- Northern Portugal.

**WE WELD LARGE DIAMETER DISCS ANYWHERE ON THE PENINSULA.**

#### **ØH15**

300 Z/21x40
350 Z/23x40
400 Z/26x40
450 Z/30x40
500 Z/30x40
500 Z/36x40
-
-

#### **ØH20**

600 Z/36x40
625 Z/36x40
725 Z/40x40
800 Z/46x40
900 Z/64x24
1000 Z/70x24
1200 Z/80x24
1300 Z/88x24
1600 Z/104x24

**DIFFERENT TYPES OF SLOTS FOR THE SAME CUTTING OF MATERIAL.**

### **SEGMENTS GRANITE ROUTERS**

#### **ØCANTO PILAstra**

300 W/10	400 W/10
300 W/15	400 W/15
300 W/20	400 W/20
300 W/30	400 W/30
350 W/10	450 W/10
350 W/15	450 W/15
350 W/20	450 W/20
350 W/30	450 W/30

Available diamond segments  
for all applications and disc  
diameters



## BLADES FOR **BRIDGE SAWS**

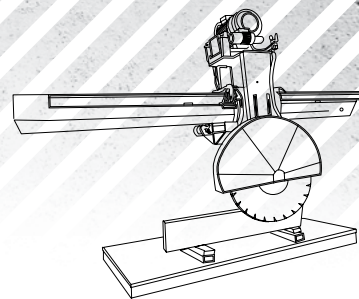

**WE MANUFACTURE FROM DISCS 115 MM. AT 3500 MM MARBLE CUTTING LINE. BIG BLADES.**

- ▶ Our engineering team design segments with the best performance for all kind of natural stones.



WET CUTTING



WET CUTTING



Ø	
300 Z/21x40	350 Z/25x40
400 Z/28x40	450 Z/32x40
500 Z/36x40	600 Z/42x40
725 Z/40x40	800 Z/46x40
900 Z/64x24	1000 Z/70x24
1200 Z/114x20	1200 Z/80x24
1300 Z/84x24	1600 Z/104x24
1600 Z/155x20	1750 Z/112x24

### GANG SAW BLADES

- Marble.

Medidas 

3860 x 3 x 18	Z28 / Z33
4010 x 3 x 18	Z28 / Z33

### WIDE RANGE OF SEGMENTS

- ▶ Segments for marble, sandstone, granite, slate, concrete, etc
- ▶ Segments of any size and shape.
- ▶ Segments designed according to your needs.



### GRINDING DIAMOND SECTORS

- ▶ For granite, marble, slate and concrete.
- ▶ Several granulometries.



### CALIBRATING DIAMONDS RINGS

- ▶ Three different granulometries.
- ▶ Flattened and ready to use.



## BLADES FOR **BRIDGE SAW**

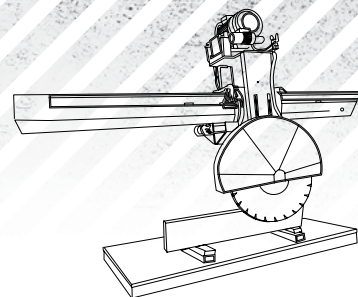

**WE MANUFACTURE FROM DISCS 115 MM. AT 3500 MM CUTTING BOARD LINE**

► We provide technical, professional and personal advice to our clients.



**WET CUTTING**



**Ø H10**

350 Z/23
725 Z/40
1000 Z/70
1000 Z/94
1200 Z/80
1200 Z/114

**SANDSTONE CUTTING LINE. BIG DIAMETER**

**Ø H15**

350 H15	725 H15	1200 H15
400 H15	800 H15	1300 H15
500 H15	900 H15	1500 H15
625 H15	1000 H15	1600 H15

## DIAMOND WIRE **FOR STATIC MACHINE**



## **WIRE GRANITE CUTTING**

Ø Perla	n° Perlas	Bar Code <b>8427648</b>	Item Code
8	36	---	---
11	30	---	---
11	33	---	---

*For static machine*

# CONSTRUCCION MACHINES



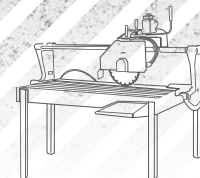

## T 600 PE\*



MODELO T600 PE

Voltage	V/HZ	230 / 50
Power	HP / W	3 / 2280
R.P.M.	RPM	2800
Protection	IP	55
Disc diameter	mm	300/350 x 25,4
Cutting high (2 times)	mm	80/165
Cutting length	mm	600
Table size	mm	500 x 510
Disc tilt	degrees	0° a 45°
Flow of bomb	lt/h	600
packing dimensions	mm	1145x695x500
Weight	Kg	97

- ▶ High Disc Adjustment by rotary wheel.
- ▶ All the models include cutting laser marker.
- ▶ Angle cutting (0° - 45°).
- ▶ Available with three-phase motor.

\*PE: Extending legs.

## RX 1100



Voltage	V/HZ	230 V / 50
Power	W	2000
R.P.M.	RPM	2800
Protection	IP	55
Disc diameter	mm	300 x 25,4
Cutting length	mm	1100
Max. cutting depth 90°	mm	110
Max. cutting depth 45°	mm	70
Table size	mm	400x235
Disc tilt	degrees	0° a 45°
Flow of bomb	lt/h	900
packing dimensions	mm	1635x595x835
Weight	Kg	73

- ▶ Folding legs with wheels
- ▶ Aluminum body.
- ▶ Laser guide.

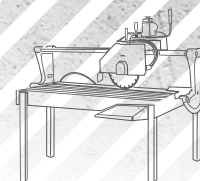

## R 12004



Voltage	V/Hz	230 / 50
Power	HP / W	4 / 3040
R.P.M.	RPM	2800
Protection	IP	55
Disc diameter	mm	300/350 x 25,4
Cutting high (2 times)	mm	85/175
Cutting length	mm	1200
Table size	mm	1450 x 580
Disc tilt	degrees	0° a 45°
Flow of bomb	lt/h	600
Dimensiones embalaje	mm	1670x786x735
Weight	Kg	172

- ▶ High Disc Adjustment by rotary wheel.
- ▶ All the models include cutting laser marker.
- ▶ Angle cutting (0° - 45°).
- ▶ Available with three-phase motor.

## CSB 316 B



Voltaje	V/Hz	230 / 50
Power	HP / W	3 / 2280
R.P.M.	RPM	2800
Disc diameter	mm	315x3x30
cutting capacity 90°	mm	100
cutting capacity 45°	mm	50
Table size	mm	550 x 800
Work surface height	mm	800
Weight	Kg.	45

- OPTIONAL
- Sliding carriage with goniometer.
  - Table extending.

- ▶ High disc adjustment.
- ▶ Anglecutting (0°-45°).
- ▶ Available with three-phase motor.

- STANDARD DOTACIÓN
- Widia saw blade.
  - Guide.
  - Suction tube.
  - Wheels .

www.stayer.es

REQUEST YOUR VISIT AT +34 91 186 08 12



WOULD YOU LIKE  
TO KNOW HOW IS  
MANUFACTURED THE  
DIAMOND DISC

YOU ARE INVITED!



©2018 - Stayer Group - Design and Marketing Department.  
Photos are indicative of the actual product. the company reserves the right to modify, change or cancellation of the indicated price without REF. 07/09/2015 notice. This catalog is intended for export.



DIFFERENT  
EXPOSURE OPTIONS



GRUPO  
**STAYER**

**ABRASIVOS GRINDING S.A.**

Área Empresarial de Andalucía - Sector 1  
c/ Sierra de Cazorla, 7 - 28320 Pinto (Madrid) - Spain  
Tel: +34 91 186 08 12  
e-mail: info@grupostayer.com

