



#uniortools  
#worldofunior  
#greatmechanicseunior  
#unior  
#uniorbiketools



**UNIOR d.d.**

Kovaška cesta 10  
3214 ZREČE  
Slovenia

T: +386 3 757 81 00  
F: +386 3 576 26 43

bike@unior.si  
www.unior-bike.com

06/2018

**UNIOR**<sup>®</sup>  
Bike tools

EN

2019

Made in Slovenia,  
since 1919.



# New

# in 2019!

## 63

**External bottom bracket sockets**



## 78

**Pedal Genie**



## 96

**2-for-1 Disc Brake Tool**



## 145

**Pro Shop Clamp**



## 149

**Pro Road Repair Stand**



### **Unior Limited Lifetime Warranty**

Unior is known worldwide for high quality precision tools. When we are talking about quality, it's not just words, we mean it. In fact we are so confident in the quality of our tools, that we back them with a limited lifetime warranty.

If Unior Tools products malfunction, under normal usage, due to defects in material or workmanship, the tool will be repaired or replaced at our cost.

Normal wear and tear, damage due to accident, abuse, modification or neglect are not covered by the warranty. Some products may also require service that is not covered by warranty. Torque wrenches and pneumatic tools are warranted for one year after date of purchase.

For more details about Unior Lifetime Warranty visit [www.uniortools.com](http://www.uniortools.com).



Multitools	A
Y wrenches	B
Hex&Torx wrenches	C
General shop tools	D
Pliers	E
Torque wrenches & Accessories	F
Bottom Bracket Tools	G
Crankset tools	H
Pedal tools	I
Chain tools	J
Cassette & Freewheel tools	K
Brake tools	L
Frame and fork tools	M
Bearing tools	N
Suspension tools	O
Wheel tools	P
Tire & Tube tools	R
Wheel truing stands & Accesories	S
Repair stands & Accessories	T
Bike storage	U
Tool sets	V
Complete service solutions	W
Work shop a la cart	X
Unior Gear	Y

# OFFICIAL TOOL PARTNER TO WORLD TOUR TEAMS

TEAM | sky

## Team Sky

British professional team took a victory on its first race in January 2010, two years later Team Sky already won Tour de France – thanks to mighty Sir Bradley Wiggins. Chris Froome won “yellow” two more times, but this is just a part of all the success this team had. Team Sky is winning because of their professionalism and modern approach to cycling racing, at the same time they raised the standards for all other teams and did enormous work for the general promotion of cycling.



TREK | Segafredo  
ZANETTI

## Trek Segafredo

Trek Segafredo is a global professional cycling team that competes at the highest level with the utmost passion and respect to the sport. Weaved around unique, rich personalities that create perfect unity, the team is open, engaging and welcomes all to come experience the grit and glory of professional cycling. Trek's factory team has great connection with their fans and riders from 18 different countries, most famous among them being Fabian Cancellara, Ryder Hesjedal, Yaroslav Popovych and Fränk Schleck.



### Etixx - Quick-Step

Belgian team captured almost 500 victories including 14 Monumentum Classics, 4 Road World Championship, 5 ITT Road World Champion, 2 TTT World Championship, 2 World Cupandan Olympic Title since his inception in 2003. The team is full of stars, including Mark Cavendish, Tom Boonen, Michal Kwiatkowski, Tony Martin, Niki Terpstra & Rigoberto Uran, which means that the team can win on every single event of the World Tour calendar.



### Movistar Team

Team had different title sponsors since the foundation in 1980, but their riders were always writing history. Over 800 victories, including 7 overall victories on Tour, 3 on Giroand 3 on Vuelta, are more than impressive numbers. Team lead by Alejandro Valverde and Nairo Quintana had an excellent start of the 2015 campaign and is always a force to be recon with.



**UNIOR devinci** FACTORY RACING





**Unior** and Canadian bike brand **Devinci** have joined forces in the name of elevating the hustle, unveiling new mountain bike team of elite **UCI World Cup** and **Enduro World Series (EWS)** racers. Both companies share a passion for racing—Devinci with super fast bikes, and Unior with the best tools to keep those machines in top shape. At the same time team continues the tradition of Unior's factory team that has been very successful in the last eight years. Team riders will race on the highest level of mountain bike sport, with main focus on **UCI MTB World Cup, Enduro World Series** and **Crankworx** events. Eight riders from three continents have already been on the top of the podium on the biggest races out there and want to continue their domination. Follow the team on [www.uniordevinci.com](http://www.uniordevinci.com) and on social media via @UniorDevinci & #UniorDevinci



Unior is an internationally renowned company with a reputation for top expertise in the field of metalworking. With its own development, Unior has secured itself the position of a renowned supplier to the automotive industry. With an exceptional tradition of smithery and with the original design of quality tools, the company has been an ally to both amateur and professional master craftsmen. Due to its comprehensive understanding of technological processes, Unior is an excellent partner in developing solutions for automatic metalworking.

### HAND TOOLS

The development of Unior hand tools constantly follows the requirements of professional and amateur craftsmen all over the world. Top quality materials and original design solutions are the basis of the extreme practicality, effectiveness and long service life of more than 5,500 hand tools. The availability of tools is ensured by a multi branch distribution network. With its cold forged products, Unior is an important supplier of tools for the European industry.



### FORGE

By drop forging steel and machining, we make forging parts for control mechanisms and gearboxes, supporting parts of chassis, components for drive shafts and sinter forging parts for the most renowned European and global makers of vehicles: VW, Audi, Renault, Dacia, BMW, ZF Lemförder & ZF Lenksysteme, Jtekt, GKN, Arvin Meritor, BPW, Schäffler KG, Betek and Cimos. Various certificates, tests and awards for excellence confirm the quality of forging parts made in Unior.



### SPECIAL MACHINES

Unior mechanical equipment provides comprehensive solutions, ranging from the concept stage to the finished product. Besides specific CNC machine tools for the serial working of aluminium castings or forging parts, Unior also offers flexible production cells, machines for deep hole drilling, for working ends and for working chassis parts, machines with a rotary table and special purpose machines. Unior is a supplier of machines for renowned car manufacturers such as VW, BMW, Audi, Daimler etc.





**MULTITOOLS**

**A**

## MULTITOOL EURO17



### Euro17 Multitool includes:

- Hex wrenches 2, 2.5, 3, 4, 5, 6, 8
- TX wrenches 10, 25
- Flat screwdriver 1.0 x 5.0
- PH1 screwdriver
- Chain tool
- Schrader & Presta valve tool
- Spoke Key 3.3, 3.45 and DT

New Euro17 Multitool - Designed and produced in Slovenia, Europe, from the best materials to the highest standard. Tool spindles are chrome plated, additionally the tips black oxide coated to ensure the highest tolerance and greater durability. Chrome vanadium 4, molybdenum vanadium 52, chrome-silicon-vanadium 5 are just some of the high end materials used on the Euro17 Multitool that make this product the best.



GLOBAL		NORTH AMERICA	
code	Art.	code	Art.
625790	1655EURO17	625901	1655EURO17-US

## MULTITOOL EURO13



### Euro13 Multitool includes:

- Hex wrenches 2, 2.5, 3, 4, 5, 6, 8
- TX wrenches 10, 25
- PH1 screwdriver
- Chain breaker
- Schrader & Presta valve tool

New Euro13 Multitool - Designed and produced in Slovenia, Europe, from the best materials to the highest standard. Tool spindles are chrome plated, additionally the tips are black oxide coated to ensure the highest tolerance and greater durability. Chrome vanadium 4, molybdenum vanadium 52, chrome-silicon-vanadium 5 are just some of the high end materials used on the Euro17 Multitool that make this product the best.



GLOBAL		NORTH AMERICA	
code	Art.	code	Art.
625791	1655EURO13	625902	1655EURO13-US



## MULTITOOL EURO7

### Euro7 Multitool includes:

- Hex wrenches 1.5, 2, 2.5, 3, 4, 5, 6

New Euro7 Multitool - Designed and produced in Slovenia, Europe, from the best materials to the highest standard. Tool spindles are chrome plated, additionally the tips are coated with black oxide coated to ensure the highest tolerance and greater durability. Chrome vanadium 4, molybdenum vanadium 52, chrome-silicon-vanadium 5 are just some of the high end materials used on the Euro7 Multitool that make this product the best.



GLOBAL		NORTH AMERICA	
code	Art.	code	Art.
625792	1655EURO7	625903	1655EURO7-US

## MULTITOOL EURO6

### Euro6 Multitool includes:

- Hex wrenches 4, 5, 6
- TX wrench 25
- Flat screwdriver 1.0 x 5.0
- PH1 screwdriver

New Euro6 Multitool - Designed and produced in Slovenia, Europe, from the best materials to the highest standard. Tool spindles are chrome plated, additionally the tips are black oxide coated to ensure the highest tolerance and greater durability. Chrome vanadium 4, molybdenum vanadium 52, chrome-silicon-vanadium 5 are just some of the high end materials used on the Euro6 Multitool that make this product the best.



GLOBAL		NORTH AMERICA	
code	Art.	code	Art.
625793	1655EURO6	625904	1655EURO6-US



## Milestones of the Unior corporation

### From Styria to the world

On the outskirts of the Pohorje Mountains, the first ironworks (foundries) were established in the 18th century. They operated as larger forges, in which land and tradesmen's tools were fashioned by hand.

1919

In 1919 the Štajerska železindustrijska družba (Styrian Iron Industry Company) forging plant, with the shortened name Štajerska Zrece, was established. It produced forged hand tools for farming, forestry and various other trades.

1950

In 1950 the plant, burned down during the war and partially renovated in the years following the war and bearing the new name of Tovarna kovanege orodja Zrece (TKO) came under state ownership. New capacities (tool shop and hand tools mechanical processing plant) comprised the basis for developing two production lines: hand tools and drop forgings.

1970

In the 1970s the plant equipped with a new development strategy also obtained a new name: Unior, tovarna kovanege orodja Zrece. The new name was formed from the words "Univerzalno Orodje" (Universal Tools), by which the company had been known for a long time.



1975

In the mid-1970s Unior began building the Rogla climatic health resort and Olympic centre on Pohorje, and a few years later construction of the Terme Zrece spa commenced and with it, the Tourism Programme.

1997

In 1997 this successful Slovenian company with stable international partnerships was transformed into the UNIOR, d. d. joint stock company. Already at that time, the company had been operating in accordance with ISO 9001 quality standards.



By the 1980s Unior had established its name as an important partner of the European automotive industry, namely as one of the largest European producers of light forgings and as one of the largest European producers of connecting rods for petrol engines. Initial development was enabled by a contract with the Renault concern, on the basis of which a joint-venture plant for the production of forgings was built in Zrece. At the same time, Unior developed its production of homokinetic joints and machine tools, initially intended for the company's own needs.

Unior Joint-Stock Company is today one of the largest and most important Slovenian exporters. With its five production segments company follows the tradition of a high quality and innovation. Committed to high utilization of own capacities, Unior enhances the brand awareness through more than 2400 employers and 32 group companies around the world.

1980

UNIVERZALNO  
100  
UNIOR



**Y WRENCHES**

**B**

## Y HEX WRENCH



The wrench is used for tightening and unscrewing screws with hex-shaped nuts. The plastic-injected handle offers a comfortable and compact grip, which enables efficient working while the high-quality material enables long-term use of the tool.

GLOBAL		NORTH AMERICA		dim
code	Art.	code	Art.	
624027	1781/2HX	624908	1781/2HX-US	4x5x6
624028		624909		2x2,5x3

## Y SOCKET WRENCH



Unior 1781/2 wrench has three most popular sockets for nuts and bolts sizes 8, 9 and 10mm. Ergonomic shape and ideal size make the tools useful for professional and amateur mechanics.

GLOBAL		NORTH AMERICA		dim
code	Art.	code	Art.	
623295	1781/2	625008	1781/2 -US	8x9x10



## Y TORX WRENCH



The wrench is used for tightening and unscrewing screws with Torx-shaped nuts. The plastic-injected handle offers a comfortable and compact grip, which enables efficient working while the high-quality material enables long-term use of the tool.

GLOBAL		NORTH AMERICA		dim
code	Art.	code	Art.	
624029	1781/2TX	624911	1781/2TX-US	10x15x25

## Y BALL END HEX WRENCH



The wrench is used for tightening and unscrewing screws with hex-shaped nuts. The plastic-injected handle offers a comfortable and compact grip, which enables efficient working while the high-quality material enables long-term use of the tool. The 1781/2HXS version features ball-end hex wrenches which are specially useful for working under angle.

GLOBAL		NORTH AMERICA		dim
code	Art.	code	Art.	
624030	1781/2HXS	624910	1781/2HXS-US	4x5x6







C

## HEX&TORX WRENCHES

36

## HEXAGONAL HEAD SCREWDRIVER WITH T-HANDLE



- material - blade - chrome vanadium, entirely hardened and tempered
- handle - polypropylene
- blade chrome plated, black anodised tip

The fine quality of the screwdriver is enhanced by a burnished tip that ensures a perfect fit to hexagon socket fasteners. The screwdriver is available in dimensions from 2,5 till 10 mm. An ergonomic handle enables comfortable and easy use.

GLOBAL		NORTH AMERICA		dim
code	Art.	code	Art.	
623238	193HX	625108	193HX-US	2
607161		625109		2.5
607162		625110		3
607163				3.5
607164		625111		4
607165		625112		4.5
607166		625113		5
607167		625114		6
607168				7
607169		625115		8
607170		625116		10

## BALL - END HEXAGONAL SCREWDRIVER WITH T - HANDLE

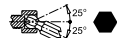

- material - blade - chrome vanadium, entirely hardened and tempered
- blade chrome plated, blacken tip
- handle - polypropylene

These screwdrivers enable working in inaccessible places. They can be used at an angle of up to 25°, allowing work to be carried out quicker and without slipping.

GLOBAL		NORTH AMERICA		dim
code	Art.	code	Art.	
608276	193HXS		193HXS-US	2.5
608277		625117		3
608278		625118		4
608279		625119		5
608280				6
608281				8
608282				10

## TX PROFILE SCREWDRIVER WITH T-HANDLE ★



- material: blade - chrome vanadium, entirely hardened and tempered
- handle - polypropylene
- blade chrome plated, blacken tip

The fine quality of the screwdriver is enhanced by a burnished tip that ensures a perfect fit to a TX form fastener. The screwdriver is available in dimensions from TX6 to TX45. An ergonomic handle enables comfortable and easy working.

GLOBAL		NORTH AMERICA		dim
code	Art.	code	Art.	
607171	193TX		193TX-US	TX6
607172				TX7
607173		625711		TX8
607174				TX9
607175		625121		TX10
607176		625122		TX15
607177		625712		TX20
607178		625123		TX25
607179				TX27
607180		625124		TX30
607181				TX40
607182				TX45

## BALL-END HEXAGON SCREWDRIVER TBI ●



- blade: chrome-vanadium-molybdenum steel, entirely hardened and tempered
- blade chrome plated, blackened tip
- handle: ergonomic shape
- three component material
- hanging hole

GLOBAL		dim
code	Art.	
611715	620TBI	2
611716		2.5
611717		3
611718		4
611719		5
611720		6
611721		8

## SCREWDRIVERS TBI

- blade: chrome-vanadium-molybdenum steel, entirely hardened and tempered
- blade chrome plated, blacken tip
- handle: ergonomic shape
- three component material
- hanging hole
- made according to standard ISO 2380-1,2

### TBI HANDLES FOR SCREWDRIVERS ARE COMPOSED OF THREE LAYERS, NAMELY:

1. layer: black PP (polypropylene) which surrounds the stem of the screwdriver and is extremely solid, preventing the turning of the screwdriver stem in the handle at high torque
2. layer: blue PP (polypropylene) which surrounds the 1st layer of the handle is very stiff and ensures the constant shape of the handle under various environmental effects
3. layer: grey TPE (thermoplastic elastomer) which partially surrounds the 2nd layer of the handle is a medium-strength material that gives the handle its final ergonomic shape, ensures a pleasant and non-slipping grip and thereby the achievement of high torques

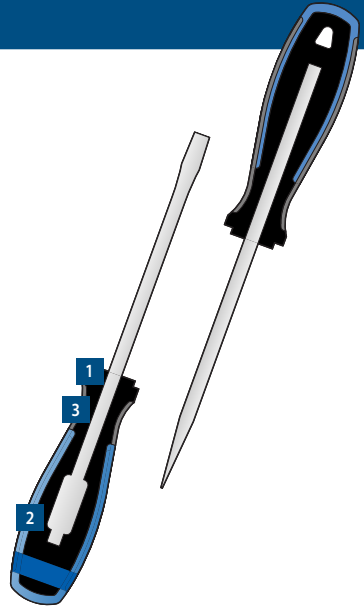

Able to fit a variety of screw profiles and exhibiting innovative three-component handles, UNIOR screwdrivers ensure great efficiency and a slip-proof grip.

The screwdrivers are made of chrome-vanadium-molybdenum steel and are additionally chrome or nickel plated. The superior quality of materials used in the Unior line of screwdrivers is complemented by ergonomically designed handles to provide an excellent hold.

With its combination of soft and hard surfaces, the special, three-component handle – a Unior patent – ensures comfort and efficient performance with minimum strain on the wrist while working. The soft material ensures maximum gripe even when oily.

Along with the varied consistency of the plastic handle practically eliminating the danger of the screwdriver slipping in the hand, the improved grip also ensures greater torque. This can also be achieved by inserting a rod in the perforation added with this purpose to all handles functioning also as a hanging hole for handier storage.

## SCREWDRIVER TBI WITH TX PROFILE



GLOBAL		NORTH AMERICA		dim
code	Art.	code	Art.	
611722	621TBI		621VDETBI	TX 6
611723				TX 7
611724				TX 8
611725				TX 9
611726		616454		TX 10
611727		616455		TX 15
611728		616456		TX 20
611729		616457		TX 25
611730		616458		TX 27
611731		616459		TX 30
611732				TX 40
611733				TX 45

## HEXAGON WRENCH



- material: chrome vanadium
- entirely hardened and tempered
- surface finish: nickel plated
- made according to standard ISO 2936 (only metric dimension)

These hexagonal wrenches are used on hexagonal socket screws. They are available in dimensions from 1.5 to 19 mm.

GLOBAL		dim
code	Art.	
607823	220/3	1.5
607824		2
607825		2.5
601036		3
601037		4
601038		5
601040		6
601041		7
601042		8
601044		10
601045		12
601046		14
601047		17
601048		19

## BALL END HEXAGON WRENCH WITH HANDLE



- blade chrome plated
- Additional handle on the wrench enables good grip.

GLOBAL		
code	Art.	dim
623145	1780/3G	5
623146		6
623147		8
623148		10

## WRENCH WITH TX PROFILE AND HOLE



- material: chrome vanadium
- surface finish: blacken to standard DIN 50938
- entirely hardened and tempered

GLOBAL		
code	Art.	dim
609173	220/7TX	10
609174		15
609175		20
609176		25
609177		27
609178		30
609179		40

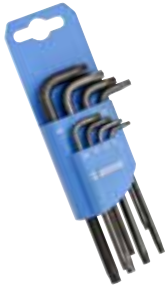

## SET OF WRENCHES WITH TX PROFILE IN PLASTIC CLIP



GLOBAL		
code	Art.	dim
613089	220/7TXXPH	TX9-40



## SET OF HEXAGON WRENCHES, LONG TYPE ON PLASTIC CLIP



GLOBAL		NORTH AMERICA		dim
code	Art.	code	Art.	
617082	220/3LPH	626770	220/3LPH-US	1/16" - 3/8" / 9
608533				1.5 - 10 / 9



## SET OF BALL END HEXAGON WRENCHES IN PLASTIC BOX



GLOBAL		
code	Art.	dim
610916	220/3SPB1	2-10/8



## WRENCH WITH TX PROFILE



- material: chrome vanadium
- entirely hardened and tempered
- surface finish: blacken to standard DIN 50938

GLOBAL		
code	Art.	dim
616991	220/7TXN	TX 6
616992		TX 7
616993		TX 8
616994		TX 9
616995		TX10
616996		TX15
616997		TX20
616998		TX25
616999		TX27

## BALL END HEXAGON WRENCH



- material: chrome vanadium
- entirely hardened and tempered
- surface finish: nickel plated

Ball end hexagonal wrench is used on hexagonal socket screws. They are available in dimensions from 1.5 to 10 mm. As it can be used at an angle of up to 25°, it enables working in inaccessible places. Work will be carried out quicker and without slipping.

GLOBAL		
code	Art.	dim
607826	220/3S	1.5
607827		2
607828		2.5
607829		3
607830		4
607831		5
607832		6
607834		8
607835		10







# #worldofunior

Working with the best mechanics in the World gives us insight into the needs of professionals. Unior is partner to numerous top mountain bike and road teams, with them we have stepped on the top of the podium on races like Tour de France, Giro di Italia and UCI Mountain Bike World Cup. Some of our partners in mountain bike racing includes Trek Factory Racing, United Ride, Commencal, Team Bulls and others. We are partner to several continental road teams as well as being official tool supplier to pro tour teams - Etixx - Quick-Step, Trek Segafredo and Movistar. Welcome to the World of Unior!

## SET OF HEXAGON WRENCHES ON PLASTIC CLIP



GLOBAL		NORTH AMERICA		dim
code	Art.	code	Art.	
607852	220/3PH	626768	220/3PH-US	1,5-10/9

## SET OF HEXAGON WRENCHES IN PLASTIC BOX



GLOBAL		
code	Art.	dim
610914	220/3PB1	2-10/8

## SET OF BALL END WRENCHES WITH TX PROFILE IN PLASTIC CLIP

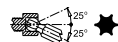

GLOBAL		
code	Art.	dim
613090	220/7TXSPH	TX9-40/8





**GENERAL SHOP TOOLS**

**D**

## A SPECIAL PROCEDURE FOR THE MANUFACTURE OF A COMBINATION WRENCH 24

**Cutting** on a machine, flat steel is cut into required shapes; the accuracy of the cut ensures minimal consumption of quality material.

**Forging** through forging procedures performed our world renowned LASCO machines, the toughness of combination wrenches is enhanced. World Class forging techniques allow us to maintain the appropriate fiber orientation of the material (the same as in the rolled blanks), which is critical in products exposed to heavy, dynamic loads (e.g. Unior wrenches).

**Trimming** the removal of flash (waste material squirting out of the thin seams between the die covers under the force of the forging hammer) is carried out by a special trimming machine; the weight of the trimmings to be removed in order for the forging to acquire the desired shape always has to be lesser than the weight of the forged part.

**Perforation** following the forging and trimming phases, perforations are made in the workpiece by punching or cutting. This procedure can be carried out either on hot or cold workpieces.

**Burring and grinding** the wrenches are contour-ground on grinding machines. Using this process, we achieve smooth surfaces on the edges of the wrench. We then smooth out the edges on the forging parts in special drums with the help of mechanical and chemical means.

**Machine marking and bending:** in conformity with Set standards, each product is impressed with its appropriate mark; next, the ring of the wrench is offSet as per relative requirements.









**Broaching** in broaching, material is removed in a single pass by a successive action of a number of cutting blades incorporated in a broach. In the production of Unior wrenches, the internal teeth of the ring are made using a MAE broaching machine.

**Tempering** tempering by heating and cooling is designed to improve the grain flow of the steel and thereby increase the toughness of the wrench at the desired points; this heat treatment process grants the Unior wrenches a long lifespan and resistance to high loads and pressure.

**Sanding** various abrasive substances are blasted onto the surface of the wrenches by means of compressed air. The abrasives burr the surface, while at the same time imparting to it a certain asperity, important for the subsequent application of a suitable galvanic (protective) coating.

**Chrome plating and polishing** wrenches are coated with a thin, solid layer of chrome dioxide to protect them from corrosion, wear and scratches; metal chrome is used in the alloying of steel and metal plate, while also giving the wrench an attractively shiny visual aspect. In certain variants, the head surfaces of the wrench are polished to present a pleasant final appearance.

## 10 MAIN STEPS OUT OF 24

- 1▶ 
- 2▶ 
- 3▶ 
- 4▶ 
- 5,6▶ 
- 7▶ 
- 8▶ 
- 9▶ 
- 10▶ 

## “THE MAIN COMMANDMENTS TOWARDS PERFECTION”

With their special safety cut, the wrenches prevent the damaging of corners and edges of the screws and nuts by distributing the force evenly over the surface away from the outer lines of the nut or screw head instead of directly on the edges.

One of the best qualities of Unior tools is their long lifespan. The wrenches are made of high-quality chrome-vanadium steel with a greater density at the points of the highest pressure, and such dimensioning and manufacture only increase their extreme power and durability. In fact, the well-studied distribution of the material renders them virtually indestructible.

The basic set of handy and serviceable wrenches is expanded by a wide range of specific-purpose variants.

All Unior wrenches meet the internationally acknowledged standards

Gap tolerance: ISO 691 (DIN 475)

Hardness: ISO 1711 (DIN 899)

Rust prevention: ISO 1456:2009



## OPEN END WRENCH

- material: chrome vanadium
- surface finish: chrome plated according to ISO 1456:2009
- polished head

These open end wrenches give long service because of precise manufacturing and outstanding quality materials.



GLOBAL		
code	Art.	dim
600061	110/1	6x7
600062		7x8
600063		7x9
600064		8x9
600065		8x10
600066		9x10
600067		9x11
600068		10x11
600069		10x12
600070		10x13
600071		10x14
600072		11x13
600074		12x13
600075		12x14
600076		13x14
600077		13x15
603846		13x16
600078		13x17
600079		14x15
600080		14x17
600081		15x17
600082		16x17
603121		16x18
600083		17x19
600084		17x22
600085		18x19
603847		18x21
600086		19x22
600087		19x24
600088		20x22
600089		21x23
600090		22x24
600091		22x27
600092		24x26
600093		24x27
600094		24x30
600095		25x28
600096		27x29
600097		27x30
600098		27x32
600099		30x32



## SET OF COMBINATION WRENCHES, SHORT TYPE IN BAG

GLOBAL		
code	Art.	dim
615465	110/1CT	6-22/8

## COMBINATION WRENCH, SHORT TYPE

- material: chrome vanadium
- surface finish: chrome plated according to ISO 1456:2009
- drop forged, entirely hardened and tempered
- polished head

Ring part with LIFE profile.

100% positioning of the wrench.

The ring part of wrench has life profile. The advantage of the new profile is that the wrench acts on the flank of nut to protect its angle.

The wrenches are produced from chrome vanadium steel that assures high quality and adequate hardness. Short type wrenches enable working in inaccessible places.



GLOBAL		
code	Art.	dim
600414	125/1	6
600415		7
600416		8
600417		9
600418		10
600419		11
600420		12
600421		13
600422		14
600423		15
600424		16
600425		17
600426		18
600427		19
600428		20
600429		21
600430		22
602089		23
602090		24
602091		25
602092		26
602093		27
602094		28
602095		29
602096		30
602097		32



## SET OF OPEN END WRENCHES IN BAG



GLOBAL		
code	Art.	dim
615478	125/1CT	8-22/8

## COMBINATION WRENCH IBEX



- material: chrome vanadium
- surface finish: chrome plated according to ISO 1456:2009
- polished head

The wrench acts on the flats to protect the corners of the nut.

3 drive surface for greater power.

100% positioning of the wrench.

Rewind action without removing the wrench.

GLOBAL		
code	Art.	dim
611762	129/1	8
611763		10
611764		11
611765		12
611766		13
611767		14
611768		15
611769		16
611770		17
611930		18
611771		19
611772		22
611773	24	

## SET OF COMBINATION WRENCHES IBEX IN BAG



GLOBAL		
code	Art.	dim
615474	129/1CT	8-22/8

## ADJUSTABLE WRENCH



- material: chrome vanadium
- surface finish: chrome plated according to EN12540:2000
- polished head

Adjustable wrenches are suitable for working on objects where we would need many wrenches in various dimensions. All those we can simply replace with adjustable wrench. Adjustable wrench can be used also together with freewheel remover, product no. 1660.

GLOBAL		
code	Art.	dim
611917	250/1	100
611918		150
601016		200

## REVERSIBLE RATCHET 1/2"



- material: special tool steel
- ergonomic heavy duty double component handle
- entirely hardened and tempered
- surface finish: chrome plated to standard EN 12540:2000
- made according to standard ISO 3315

Thanks to their high-quality manufacture, working with Unior ratchets is safer and more accurate. The operation of the ratchet accommodating the sockets is based on a 75-teeth mechanism, which divides the 360° full circle into sections of 4.8-degree angles and thus guarantees simpler use even at nearly inaccessible points. With larger ratchet increments, fewer turns and less effort, you can achieve greater reliability and higher precision. One of the advantages of Unior ratchets is the special socket retention system with a one-touch release button ensuring greater safety at work and an increased socket locking speed.

GLOBAL		NORTH AMERICA		dim
code	Art.	code	Art.	
611782	190.1/1ABI	625107	190.1/1ABI-US	260

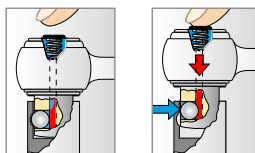

Safety lock system.  
Higher speed and effectiveness.

# 190.1/1ABI

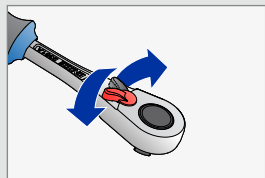

Ratchet: works both way, screw direction can be changed with button.

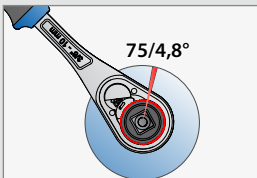

75 - teeth.  
The more teeth, the smaller the angle of rotation, which means that it can be used in extremely tight spaces.  
More teeth and an improved mechanism also result in the ratchet's increased endurance, which exceeds the prescribed DIN standard by more than 30 %.

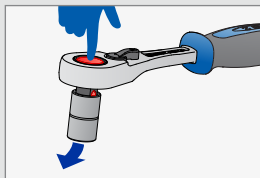

Safety lock system.  
Locking system prevents the socket slipping off the ratchet.

## REVERSIBLE RATCHET 3/8"

- material: special tool steel
- ergonomic heavy duty double component handle
- 75 - teeth
- surface finish: chrome plated to standard ISO 1456:2009
- made according to standard ISO 3315

The ratchet has a safety lock system, which means that socket is realized from ratchet by simply pressing a button. Speed of working is assured with the locking system and mechanism for realizing the socket. The ratchet has 75 teeth, which enables working in inaccessible places. With larger ratchet increments, fewer turns and less effort, you can achieve greater reliability and higher precision. One of the advantages of Unior ratchets is the special socket retention system with a one-touch release button ensuring greater safety at work and an increased socket locking speed.



GLOBAL		
code	Art.	dim
612501	238.1/1ABI	200

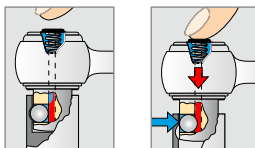

Safety lock system.  
Higher speed and effectiveness.

## SLIDING T - HANDLE 1/2"



- material: chrome vanadium
- surface finish: chrome plated according to ISO 1456:2009
- made according to standard ISO 3315
- entirely hardened and tempered

GLOBAL		
code	Art.	dim
600876	190.3/1	300

## SLIDING T-HANDLE 3/8"



- material: chrome vanadium
- surface finish: chrome plated according to ISO 1456:2009
- polished head
- made according to standard ISO 3315
- entirely hardened and tempered

GLOBAL		
code	Art.	dim
605341	238.3/1	165

## BITS AND SOCKETS SET



Unior's bits and sockets set for bicycle service includes all the necessary items for the most common service on a bicycle.

Smaller sockets and bits are 1/4" while the bigger ones are 3/8".

To ensure the use of all of them on any of the ratchet or torque wrench size, the set also includes two convert adapters - to use 1/4" on a 3/8" and the other way around.

All items can be used on a ratchet or a torque wrench.

All the items in the set are nicely arranged inside the SOS foam tray.

### The set contains:

- Torx bits sizes 25, 27 and 30
- Hex bits sizes 3, 4, 5, 6, 8, 10
- Socket sizes 8, 9, 10, 11, 12, 13, 14, 15
- Adapters 1/4" - 3/8" and 3/8" - 1/4"

GLOBAL		
code	Art.	dim
624040	1782	/19

## PRO SOCKET HANDLE 1/2"



GLOBAL		NORTH AMERICA		dim
code	Art.	code	Art.	
627084	190.8/2BI	627085	190.8/2BI-US	250

## SOCKET 1/2"



- material: chrome molybdenum
- surface finish: chrome plated according to ISO 1456:2009
- made according to standard ISO 2725-1 (only metric dimension)

GLOBAL		
code	Art.	dim
605307	190/1 6p	8
610155		9
600851		10
600852		11
600853		12
600854		13
600855		14
600856		15
600857		16
600858		17
600859		18
600860		19
600861		20
600862		21
600863		22
600864		23
600865		24
600866		25
600867		26
600868		27
600869		28
610156		29
600871		30
600872		32

## SOCKET 3/8"



- surface finish: chrome plated according to ISO 1456:2009
- polished
- drop forged, entirely hardened and tempered
- made according to standard ISO 2725-1 (only metric dimension)

GLOBAL		
code	Art.	dim
605322	238/1 6p	6
605323		7
605324		8
605325		9
605326		10
605327		11
605328		12
605329		13
605330		14
605331		15
605332		16
605333		17
605334		18
605335		19
605336		20
605337		21
605338	22	

## HEXAGONAL SCREWDRIVER SOCKET 1/2"



- material: socket: chrome vanadium, chrome plated
- material: bit: special tool steel, anticorrosive oiled

GLOBAL		
code	Art.	dim
600978	192/2HX	4
603420		5
603421		6
603422		7
603423		8
605923		9
603424		10
603425		12
603426		14
624034		15
603427		17
603428		19

## HEXAGONAL SCREWDRIVER SOCKET 3/8"



- material: bit: special tool steel, anticorrosive oiled
- entirely hardened and tempered
- made according to standard DIN 7422 (only metric dimension)

GLOBAL		
code	Art.	dim
612082	236/2HX	4
612083		5
612084		6
612085		8
612086		10

## SOCKET WRENCH WITH T-HANDLE



- material: blade - chrome vanadium, entirely hardened and tempered
- surface finishing: blade chrome plated according to ISO 1456:2009
- handle - polypropylene

These wrenches have fixed sockets from 5.5 mm to 17 mm. The ergonomic shape ensures comfortable and easy use.

GLOBAL		NORTH AMERICA		
code	Art.	code	Art.	dim
608283	193N	625120	193N-US	5.5
608284		6		
608285		7		
608286		8		
608287		9		
608288		10		
608289		11		
608290		12		
608291		13		
608292		14		
608293		15		
608294		16		
608295		17		

## FLAT SCREWDRIVER TBI

• made according to standard ISO 2380-1,2



GLOBAL		NORTH AMERICA		dim
code	Art.	code	Art.	
612810	605TBI		603VDETBI	0.4X2.5X60
611687		616436		0.4X2.5X75
611688				0.5X3.0X80
612811		616437		0.5X3.0X100
611689				0.5X3.0X125
612812				0.5X3.0X150
612813				0.6X3.5X75
611690		616438		0.6X3.5X100
611691				0.6X3.5X125
611692		616439		0.8X4.0X100
612814				0.8X4.0X125
611693				0.8X4.0X150
612815				0.8X4.0X200
612816				1.0X5.5X100
611694		616440		1.0X5.5X125
611695				1.0X5.5X150
612817				1.2X6.5X100
612818				1.2X6.5X125
611696		616441		1.2X6.5X150

## CROSSTIP (PH) SCREWDRIVER TBI

• made according to standard ISO 8764-1,2



GLOBAL		NORTH AMERICA		dim
code	Art.	code	Art.	
611701	615TBI	616443	613VDETBI	PH 0X60
611702		616444		PH 1X80
611703				PH 1X200
611704		616445		PH 2X100
611705				PH 2X150
611706				PH 2X200



## MAGNETIC TRAY



- material: stainless steel, corrosion resistant
- keeps parts and tools right where you need them
- holds any small nuts, bolts and steel parts

With its powerful rubber-protected magnet, this magnetic tray is suitable for practically all industrial applications ranging from car repair shops to everywhere where it can be attached to a metal surface. It can be used in all positions - the magnet is so powerful that the tray can even be fitted upside-down. The tray is intended for protecting screws, nuts and the like against being misplaced, and for storing them in a central location to minimise the time needed to find a specific item.

GLOBAL		
code	Art.	dim
619728	2086	150x40

## MEASURING TAPE



- plastic double component casing
- with stop and clip

GLOBAL		NORTH AMERICA		dim
code	Art.	code	Art.	
612793	710R	625129	710R-US	2m
612794				3m
612795				5m

## VERNIER



- accuracy: 0,02mm/0,001"
- function: measurement of internal dimensions, of external dimensions, of depth, of steps
- made according to standard DIN 862
- dual scale in inch and mm

GLOBAL		
code	Art.	dim
612035	271	0-150mm



## DIGITAL VERNIER

- accuracy: 0,02mm/0,001"
- measuring speed: 1.5m/sec
- function: measurement of internal dimensions, of external dimensions, of depth, of steps
- made according to standard DIN 862
- dual scale in inch and mm

GLOBAL		
code	Art.	dim
619881	270A	0-150mm

## ADJUSTABLE SPANNER WRENCH

- material: chrome vanadium
- entirely hardened and tempered
- surface finish: chrome plated according to ISO 1456:2009
- double plastic dipped handles

The 2.3 and 2.8 mm pins are interchangeable, the distance between them is adjustable. The biggest difference between the pins is 50 mm open and 10 mm closed.



GLOBAL		NORTH AMERICA		dim
code	Art.	code	Art.	
616294	253/2DP	624933	253/2DP-US	2.3,3.8

## PIN SET 2 PIECES FOR 253/2DP



GLOBAL	
code	Art.
621020	253.1/4A



## BUMPING HAMMER

- non rebound
- lacquered metal housing
- metal tubular handle lacquered, with plastic grip
- inserts polyurethane broad applications
- high security

GLOBAL		
code	Art.	dim
605492	820A	Fl 27
605493		Fl 32
605494		Fl 40



## LOCKSMITHS` HAMMER

- material: special tool steel
- drop forged
- striking face and nose induction hardened
- surface finish: lacquered
- ash wood handle with special oval wedge
- made according to standard DIN 1041

GLOBAL		
code	Art.	dim
601797	812	150
601799		200
601801		250

# 819A

## STRUCTURE AND MATERIAL:

- Hammer is composed of casing with handle (Pos. 1), accessory (Pos. 2), coil and filling
- Casing with handle is made of pipe (alloyed steel) which is distinguished with great tensility and is resist to mechanical injuries and can take great strains. The surface is protected by powder lacquering which ensures that it is not sensitive for surface damages
- The accessory is made out of plastic substance which is distinguished by great resilience in all weather conditions and take great strains under blow pressure
- The coil is made of plastic material which feels pleasant to the touch and does not slip from the hand
- It is ergonomically shaped and thus enables a good grip.

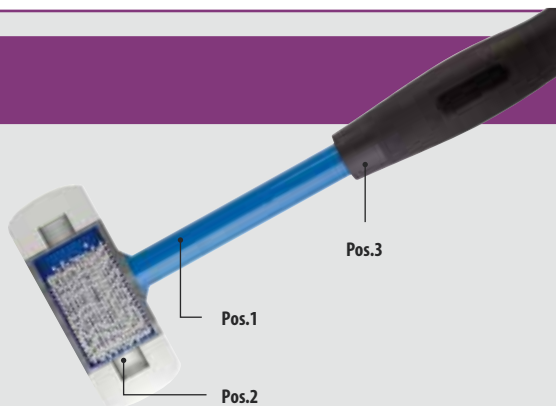

## THE WAY OF USE:

- Hammer is used for hammering, adjustment, moving of different objects which must not be harmed.
- It has an advantage ahead of ordinary hammers with plastic accessory that it does not bounce on impact from surface and thus the impact of the hammer force is increased.

## BUMPING HAMMER

- non rebound
- lacquered metal housing
- metal tubular handle lacquered, with plastic grip
- inserts polyurethane broad applications

The inserts, made from polyurethane, are exchangeable and they are acid and oil resistant. The hammer can be used with crown race setting system (Product no. 1683/4).



GLOBAL		NORTH AMERICA		dim
code	Art.	code	Art.	
615034	819A	626485	819A-US	950

## HACKSAW

- light compact with ergonomically designed handle
- frame chrome plated, handle blue lacquered
- two blade position

GLOBAL		
code	Art.	dim
621531	750B	400



## CARBON SAW BLADE FOR 750B, 2 PCS SET

GLOBAL	
code	Art.
623099	750.1CAR

## FLAT FILE WITH HANDLE, HALF SMOOTH

- material: carbon tool steel
- all files have second cut

GLOBAL		
code	Art.	dim
619295	760H1/2S	100
619296		150



## FLAT FILE WITH HANDLE, BASTARD



GLOBAL		NORTH AMERICA		dim
code	Art.	code	Art.	
612992	760HB	625715	760HB-US	200



## HALF-ROUND FILE WITH HANDLE, HALF SMOOTH



GLOBAL		
code	Art.	dim
619307	761H1/2S	100
619308		150



## ROUND FILE WITH HANDLE, HALF SMOOTH



GLOBAL		
code	Art.	dim
619319	763H1/2S	100
619320		150



## ROUND FILE WITH HANDLE, BASTARD



GLOBAL		NORTH AMERICA		dim
code	Art.	code	Art.	
613011	763HB	625714	763HB-US	200



## THREE-SQUARE FILE WITH HANDLE, HALF SMOOTH



GLOBAL		
code	Art.	dim
619331	764H1/2S	100
619332		150



## SQUARE FILE WITH HANDLE, HALF SMOOTH



GLOBAL		
code	Art.	dim
619343	765H1/2S	100
619344		150

## SET OF FILES, HALF SMOOTH IN CARTON BOX



GLOBAL		
code	Art.	dim
619468	762/5 1/2S	150

## IRONGATOR ENGINEER'S VICE



- housing from gray iron casting
- drop forged jaws from tool carbon steel, hardened and tempered
- lacquered housing, jaws anticorrosive oiled, other parts zinc plated
- spindle protected against damage
- uniPRO slides ensure precise running of moving parts
- engineer's vice can be combined with swivel base

GLOBAL		
code	Art.	dim
621564	721/6	80
621481		125
621567		150
621570		200

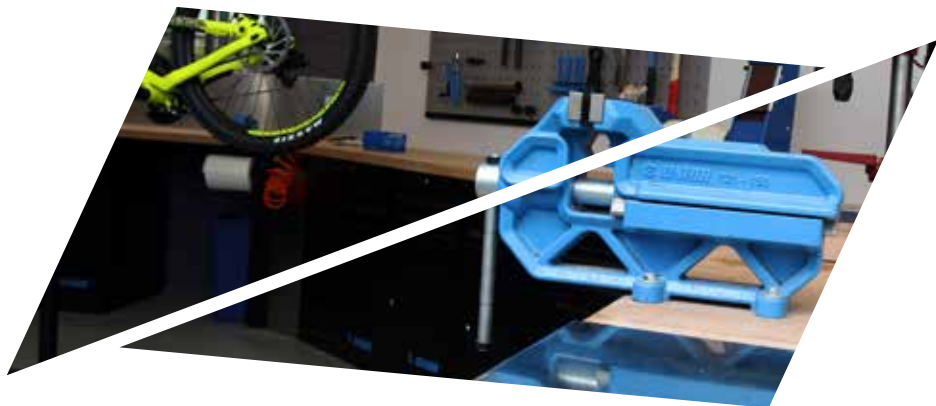

# 721/6 | 721Q/6

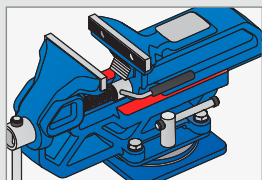

UniPRO slides ensure precise running of moving parts.

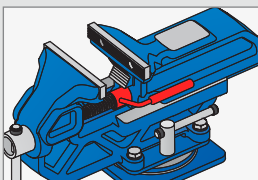

Quick moving system.

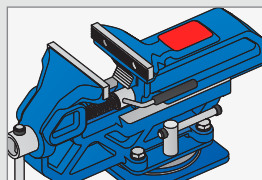

Grounded working place.

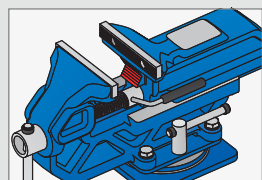

Fixed jaws for pipes holding.

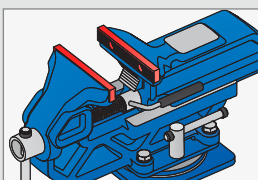

Drop forged jaws from tool carbon steel, hardened and tempered.

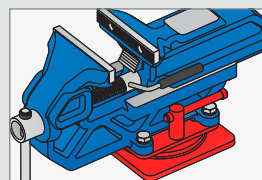

Swivel base can be rotated for 360°.



## QUICK IRONGATOR ENGINEER'S VICE WITH QUICK MOVING SYSTEM

- housing from gray iron casting
- drop forged jaws from tool carbon steel, hardened and tempered
- lacquered housing, jaws anticorrosive oiled, other parts zinc plated
- uniPRO slides ensure precise running of moving parts
- engineer's vice can be combined with swivel base
- quick moving system

GLOBAL		NORTH AMERICA		dim
code	Art.	code	Art.	
621482	721Q/6	625130	721Q/6-US	125
621568		625131		150



## SWIVEL BASE FOR 721/6 AND 721Q/6



- housing from gray iron casting
- material other parts: special tool steel
- swivel base can be rotated for 360°

GLOBAL		
code	Art.	dim
621566	721.1/6	80
621483		125
621569		150
621572		200



## SPARE ALUMINIUM JAWS FOR 721/6 AND 721Q/6



- material: aluminium
- set 2 pieces

GLOBAL		
code	Art.	dim
619026	722.1AL	125
619027		150



**PLIERS**

**E**

## STEEL WIRE CUTTER



- material: special tool steel
- entirely hardened and tempered
- surface finish: chrome plated to standard ISO 1456:2009
- cutting brake cables to diameter 1,65 mm
- cutting derailleur cables to diameter 1,25 mm

The design of the steel wire cutter enables multiple operations, such as cutting of brake and derailleur cables as well as the squeezing of the cable ends to prevent fraying. It has been developed in connection with well known repair shops. Specially hardened and tempered cutting edge has high resistance against dulling and allows precise cutting without any damages.

GLOBAL		NORTH AMERICA		dim
code	Art.	code	Art.	
620591	584/2POLLY	624906	584/2POLLY-US	180

## CABLE PULLER PLIERS WITH LOCK



- material: special tool steel, hardened and tempered
- surface finish: chrome plated according to ISO 1456:2009
- double plastic dipped handles

The basic function of the inner wire pliers is to tension brake and derailleur steel cables. It is used for holding the inner cable and pulling it out of the housing. The safety lock is activated with a thumb push. The pliers can now be released and the cable fixed. The lock is automatically released by squeezing handles together. The additional safety lock enables easier, faster and more comfortable use.

GLOBAL		NORTH AMERICA		dim
code	Art.	code	Art.	
619719	1642.1/2P	624917	1642.1/2P-US	185

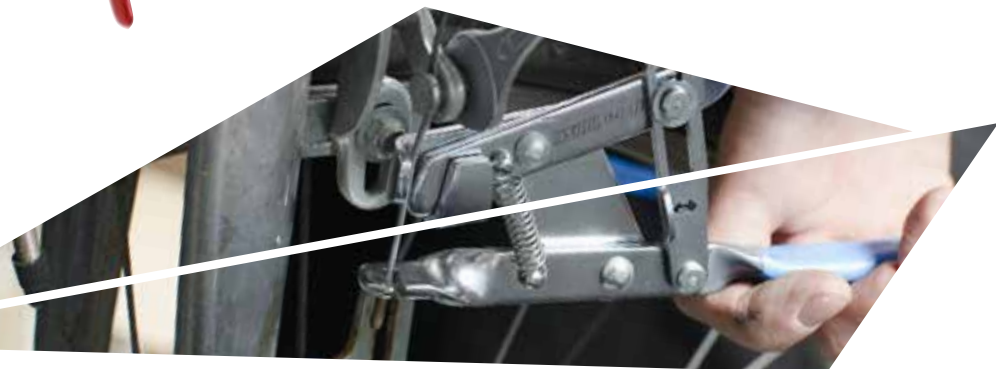

## MASTER LINK PLIERS

- tool can be used by professional or amateur mechanics

Master link pliers are for commonly used chains with master link, SRAM Powerlink or the KMC Missing Link. After chain use and due to mud and rust, it can be impossible to remove the master link with only your hands. With Unior 1720/2DP Master Link pliers, removal of the master link is easy.



GLOBAL		NORTH AMERICA		dim
code	Art.	code	Art.	
623296	1720/2DP	624907	1720/2DP-US	177



## CHAIN RIVET PLIERS

- material: special tool steel, hardened and tempered
- drop forged, entirely hardened and tempered
- surface finish: chrome plated according to ISO 1456:2009
- pin induction hardened

The chain rivet pliers have been developed to enable both professional and home mechanics to work quickly and safely on bicycle chains. Higher functionality and practicality are the advantages of the chain rivet pliers and with this unique design less physical effort is required to extract the rivet from the chain. Jobs will be performed quickly and comfortably without damage to the rivet or chain plate. The ergonomic design enables single handed use.



GLOBAL		NORTH AMERICA		dim
code	Art.	code	Art.	
615377	1640/1DP	624914	1640/1DP-US	240



## REPLACEABLE PIN FOR CHAIN RIVET PLIERS



GLOBAL		dim
code	Art.	
605956	1640.1/4	



## TIRE SETTER



- material: chrome vanadium
- drop forged, entirely hardened and tempered
- surface finish: chrome plated to standard ISO 1456:2009
- double plastic dipped handles

The pliers are intended for fast straightforward tire removal - especially tires that have already bonded with the rim. Using the pliers, we compress the tire so that it detaches from the bead of the rim. A strong grip facilitates the removal of the tires. The well designed shape of the pliers enables the separation of the tire from the rim and ensures that the inner tube is not punctured when removing the tire. The pliers are chromed and laminated with plastic for a more comfortable grip.

GLOBAL		NORTH AMERICA		dim
code	Art.	code	Art.	
617586	1601/2DP	624948	1601/2DP-US	300



## DIAGONAL CUTTING NIPPERS



- material: special tool steel
- drop forged, entirely hardened and tempered
- cutting edges induction hardened
- surface finish: chrome plated to standard ISO 1456:2009
- heavy duty double - component handles
- made according to standard ISO 5749

GLOBAL		NORTH AMERICA		dim
code	Art.	code	Art.	
607883	461/1BI	610426	461/1VDEBI	140
607884		610427		160



## COMBINATION PLIERS



- material: special tool steel
- drop forged, entirely hardened and tempered
- cutting edges induction hardened
- surface finish: chrome plated to standard ISO 1456:2009
- heavy duty double - component handles
- made according to standard ISO 5746

Combination pliers are the basic tool of every bike mechanic, and enable the cutting of soft and medium hard wire and gripping of diverse work pieces. Ergonomic shape ensures maximum grip on the handle.

GLOBAL		NORTH AMERICA		dim
code	Art.	code	Art.	
607870	406/1BI	610421	406/1VDEBI	160
607871		610422		180
607872		610423		200
608354		610424		220

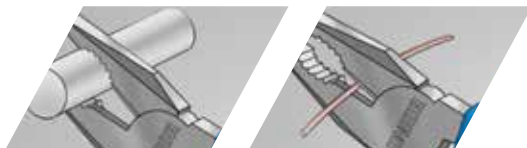

## LONG FLAT NOSE PLIERS



- material: special tool steel
- drop forged, entirely hardened and tempered
- surface finish: chrome plated to standard ISO 1456:2009
- heavy duty double - component handles
- gripping surface serrated
- made according to standard ISO 5745

GLOBAL		NORTH AMERICA		dim
code	Art.	code	Art.	
607878	472/1BI	610430	472/1VDEBI	140
607879				160

## LONG NOSE PLIERS WITH SIDE CUTTER AND PIPE GRIP, BENT



- material: special tool steel
- drop forged, entirely hardened and tempered
- cutting edges induction hardened
- surface finish: chrome plated according to EN12540:2000
- gripping surface serrated
- jaws bent to an angle of 45°
- made according to standard ISO 5745

Jaws bent to an angle of 45°.

The long bent jaws enable simple and precise clenching of nuts and screws.

The strong jaws enable good grip.

Half round jaws bent to an angle of 45° enable perfect grip in inaccessible places. Gripping serrated surface ensure an accurate and secure grip.

GLOBAL		NORTH AMERICA		dim
code	Art.	code	Art.	
607966	512/1BI	610438	512/1VDEBI	170
607967		610439		200

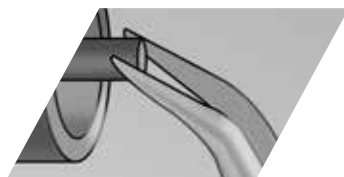

## VARIABLE JOINT "HYPO" PLIERS



- material: special tool steel
- surface finish: chrome plated according to EN12540:2000
- heavy duty double - component handles
- drop forged, entirely hardened and tempered
- closing mechanism
- Perfect adaptability to the work piece whatever the shape. Quick and simple grip.

The Hypo pliers are self-adjusting for which it is not necessary to preset the width of the jaws.

One hand self adjusting operation.

The pliers adapt perfectly to the work piece.

Maximum jaw aperture up to  $\varnothing 40$  mm.

The locking mechanism enables easier storage when the pliers are not in use.

GLOBAL		
code	Art.	dim
611780	442/1HYPO	240



## WATERPUMP BOX JOINT PLIERS



- material: chrome vanadium
- drop forged, entirely hardened and tempered
- surface finish: chrome plated to standard ISO 1456:2009

Jaw aperture adjustable in 7 positions.

Jaws are always parallel to protect the work piece from being damaged.

Python pliers have jaws that are adjustable in 7 positions. The jaws are always parallel to protect the work piece from being damaged. When working on chromed or polished work pieces the additional plastic jaws should be used.

GLOBAL		NORTH AMERICA		dim
code	Art.	code	Art.	
615032	449/1PYTHON	625713	449/1PYTHON-US	240



## PLASTIC JAW FOR 449/1PYTHON



GLOBAL		dim
code	Art.	
615033	449.1	/2



## EXTERNAL LOCK RINGS PLIERS, STRAIGHT



- material: special tool steel
- drop forged, entirely hardened and tempered
- head polished
- surface finish: chrome plated according to EN12540:2000
- tips black finish
- double plastic dipped handles
- made according to standard DIN 5254 form A

GLOBAL		NORTH AMERICA		dim
code	Art.	code	Art.	
621187	532PLUS/1DP	625125	532PLUS/1DP-US	140 (3-10mm)

## EXTERNAL LOCK RINGS PLIERS, BENT



- material: special tool steel
- drop forged, entirely hardened and tempered
- head polished
- surface finish: chrome plated to standard ISO 1456:2009
- tips black finish
- made according to standard DIN 5254 form B
- double plastic dipped handles

GLOBAL		NORTH AMERICA		dim
code	Art.	code	Art.	
621195	534PLUS/1DP	625126	534PLUS/1DP-US	140 (3-10mm)

# 536PLUS/1DP | 538PLUS/1DP

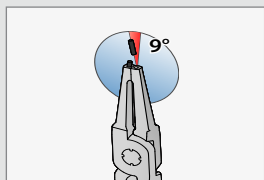

The tips are inserted into the jaw at an angle that prevents the circlip from sliding off the tips.

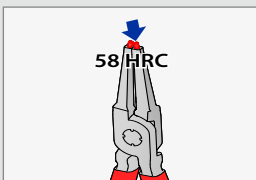

Tips hardened to 58 HRC prevent bending or breaking during the removal or insertion of circlips.



## INTERNAL LOCK RINGS PLIERS, STRAIGHT



- material: special tool steel
- drop forged, entirely hardened and tempered
- head polished
- surface finish: chrome plated according to EN12540:2000
- tips black finish
- double plastic dipped handles
- made according to standard DIN 5256 form C

GLOBAL		NORTH AMERICA		dim
code	Art.	code	Art.	
621203	536PLUS/1DP	625127	536PLUS/1DP-US	140 (8-13mm)

## INTERNAL LOCK RINGS PLIERS, BENT



- material: special tool steel
- drop forged, entirely hardened and tempered
- head polished
- surface finish: chrome plated to standard ISO 1456:2009
- tips black finish
- double plastic dipped handles
- made according to standard DIN 5256 form D

GLOBAL		NORTH AMERICA		dim
code	Art.	code	Art.	
621211	538PLUS/1DP	625128	538PLUS/1DP-US	140 (8-13mm)

## SET OF LOCK RINGS PLIERS PLUS IN BAG



GLOBAL		
code	Art.	dim
621623	539PLUS/1DPCT	140 (3-13mm)





## TORQUE WRENCHES & ACCESSORIES

F

## CLICK TYPE TORQUE WRENCH

Slipper torque wrench has reversible ratchet head, it operates in clockwise direction. Tightened on left and right hand threads. Unmistakable signal is heard when set torque is reached.



GLOBAL		dim
code	Art.	
615485	264	2 - 24Nm
615486		5 - 110Nm



1  
Unscrew the bottom bolt, to release screw for torque adjustment.



3  
Screw back bottom bolt, to fix torque adjustment.



2  
Adjust to designated torque.



4  
Adjust and start tightening (prescribed torque direction). When you hear audio signal (click), the designated torque is reached. Stop tightening.

NEW!



## ELECTRONIC TORQUE WRENCH

Torque wrench specially designed for work on bikes. Both versions in a size to best fit the intended use, precise and easy to use. Smaller version features a 1/4" square drive and will allow you to work on even the most hidden bolts with low torque values. Bigger version features 1/2" square drive and will accept all our bottom bracket sockets, suspension top cap sockets and cassette lock rings without any adapters.

- antislip handle
- target torque warning: buzzer + 2 LED lights
- operation mode: peak hold / track
- unit selection: N-m, in-lb, ft-lb, kg-cm
- gear teth: 60
- battery: 1xAAA (not included), compatible with rechargeable battery
- warranty: 10.000 cycle / one year
- online calibrations
- auto power off after 5 min

GLOBAL					
code	Art.	square drive (inches)	range (Nm)	accuracy	resolution
627784	266B	1/4"	1 - 20 Nm	CW: +/- 3 % CCW: +/- 4 %	0,01 Nm, 0,01 ft-lb 0,01 in-lb, 0,1 kg-cm
627785		1/2"	4 - 85 Nm	CW: +/- 3 % CCW: +/- 4 %	0,01 Nm, 0,01 ft-lb 0,01 in-lb, 0,1 kg-cm

## BITS AND SOCKETS SET



Unior's bits and sockets set for bicycle service includes all the necessary items for the most common service on a bicycle.

Smaller sockets and bits are 1/4" while the bigger ones are 3/8".

To ensure the use of all of them on any of the ratchet or torque wrench size, the set also includes two convert adapters - to use 1/4" on a 3/8" and the other way around.

All items can be used on a ratchet or a torque wrench.

All the items in the set are nicely arranged inside the SOS foam tray.

### The set contains:

- Torx bits sizes 25, 27 and 30
- Hex bits sizes 3, 4, 5, 6, 8, 10
- Socket sizes 8, 9, 10, 11, 12, 13, 14, 15
- Adapters 1/4" - 3/8" and 3/8" - 1/4"

GLOBAL		
code	Art.	dim
624040	1782	/19





**G**

## **BOTTOM BRACKET TOOLS**

NEW!



## EXTERNAL BOTTOM BRACKET SOCKETS

All models of bottom bracket sockets are precision CNC machined tools for installation and removal of different external bottom bracket cups. They are made of aluminum billet and anodized red for durable finish and precise fit, that won't damage aluminum external bottom bracket cups. Knurling on the side of the socket creates better grip when threading cups by hand, meanwhile 1/2" square drive makes it easy to use with torque wrenches, ratchets and fixed handles.

Like all of Unior's tools, bottom bracket sockets are proudly designed and manufactured in Slovenia.

GLOBAL		
code	Art.	
627619	1671.BB9000	Bottom bracket socket BB9000
627620	1671.BBR60	Bottom bracket socket BBR60
627621	1671.BSA30	Bottom bracket socket BSA30
627622	1671.MEvo	Bottom bracket socket MegaEVO
627623	1671.16N	Bottom bracket socket 16 Notch

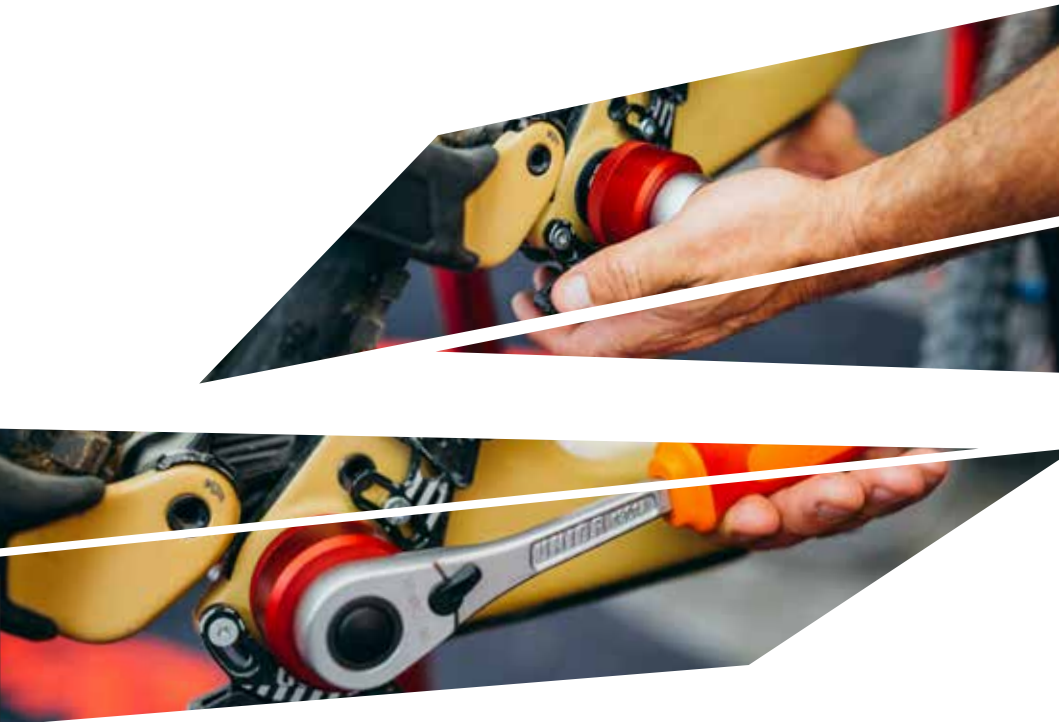



## BOTTOM BRACKET WRENCH 16 NOTCH



- material: special tool steel, hardened and tempered
- surface finish: chrome plated according to ISO 1456:2009
- ergonomic heavy duty double component handle

The wrench is used to remove and install Shimano® Hollowtech II, Campagnolo® Ultra-Torque and Power Torque, Race Face®, FSA®, SRAM®, Truvativ®, Chris King® bottom brackets as well as many and others. Small wrench is included for removal and installation of Shimano plastic bolts that are used on the Hollowtech II cranksets. The 1609/2BI wrench also fits on the external centerlock disc nut.

GLOBAL		NORTH AMERICA		dim
code	Art.	code	Art.	
615536	1609/2BI	624903	1609/2BI-US	350

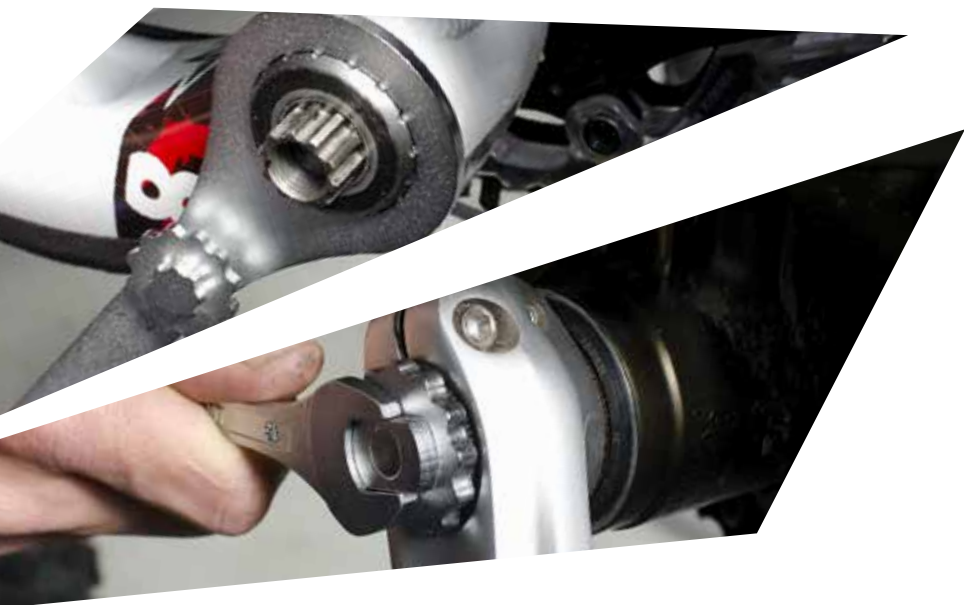

## OPEN BOTTOM BRACKET WRENCH 16 NOTCH



- material: special tool steel, hardened and tempered
- surface finish: chrome plated according to ISO 1456:2009

The open bottom bracket wrench is used to remove and install Shimano® Hollowtech II, Campagnolo® Ultra-Torque and Power Torque, Race Face®, FSA®, SRAM®, Truvativ®, Chris King® bottom brackets as well as many and others. The 1609/2HOBBY wrench also fits on the external centerlock disc nut.

Tool also fits the disc brake rotor nuts with 16 external notches.

GLOBAL		NORTH AMERICA		dim
code	Art.	code	Art.	
623424	1609/2HOBBY	624935	1609/2HOBBY-US	310

## BOTTOM BRACKET WRENCH 8 NOTCH



- material: special tool steel, hardened and tempered
- surface finish: chrome plated according to ISO 1456:2009
- ergonomic heavy duty double component handle

This tool is made for the installation and removal of XTR® and Dura Ace bottom brackets and enables easy work without slippage and damage.

GLOBAL		NORTH AMERICA		dim
code	Art.	code	Art.	
615534	1608/2BI	624960	1608/2BI-US	350

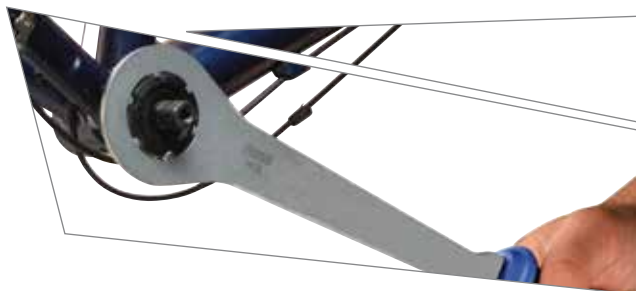

## CARTRIDGE BOTTOM BRACKET WRENCH

- material: special tool steel, hardened and tempered
- ergonomic heavy duty double component handle

The double threaded screw enables you to use this tool for Shimano standard bottom brackets as well as for Shimano Octalink and Truvativ bottom brackets.

It is composed of wrench, product no. 1671.1, screw with nut and handle.

This tool allows you to thread the wrench into the axle with the additional screw. This prevents the wrench from slipping and damaging the bottom bracket nut. Work is made easy by the 350 mm long handle with the two part ergonomic sleeve. The same procedure can be used for installation. The screw is 24 mm AF and is used with a 24 mm wrench or with a torque wrench. The handle can be taken down if necessary.



GLOBAL		NORTH AMERICA	
code	Art.	code	Art.
623087	1671.8/2BI	624919	1671.8/2BI-US

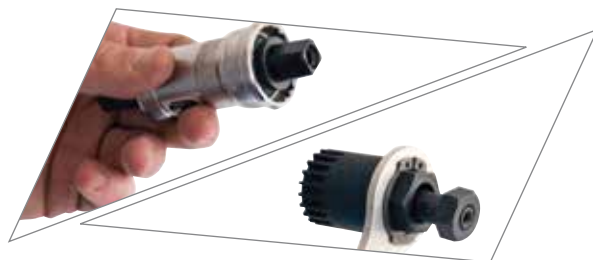

## BB30 REMOVAL TOOL

This tool is designed to remove the non-threaded bottom bracket bearings of the BB30 bottom bracket system. The removal tool will safely drive the bearings out of the BB30 bottom bracket shell.



GLOBAL	
code	Art.
621660	1625/2



## BB90 REMOVAL TOOL



This tool is designed to remove the non-threaded bottom bracket bearings and cups of the BB90 bottom bracket system. It also supports other press fit standards with 24mm spindle, such as BB86, BB92, SRAM Press Fit GXP. The removal tool will pull the bearings & cup from the frame. Carefully insert the guide head of removal tool through the bottom bracket cup (marked green).

GLOBAL	
code	Art.
623085	1625/2BB90

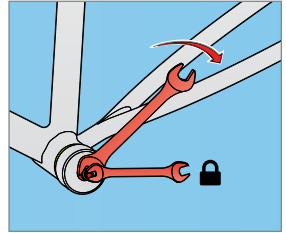
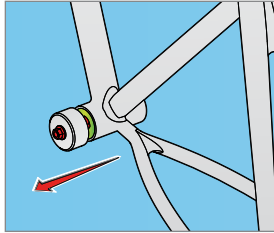
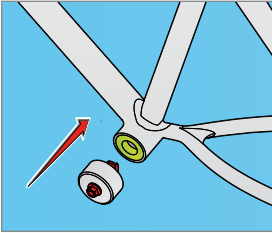

## ADJUSTABLE CUP WRENCH, FOR OLDER BOTTOM BRACKET MODELS

- material: special tool steel, hardened and tempered

The wrench is used for installing and removing of older bottom brackets. The wrench fits perfectly in the hand while the slim body and gap form enable quick and efficient installation and removal of older types of bottom brackets. The length of the key is 204 mm.



GLOBAL		
code	Art.	dim
618414	1672/2	27.3x31

## BOTTOM BRACKET SHELL INSTALLATION TOOL



- material: special tool steel
- surface finish: blacken to standard DIN 50938
- dimension: 35,8 mm and 36,3 mm

This tool is used for the installation and removal 35.8 mm and 36.3 mm bottom bracket shell. It is made of precision tool steel with heat treatment and surface protection. The advantage of the tool is that it prevents slipping off the shell.

GLOBAL	
code	Art.
616293	1607/4



## SPARE HEAD FOR 1607/4



GLOBAL	
code	Art.
623383	1607.1/4



## CAMPAGNOLO POWER AND ULTRA TORQUE FULL SET, ALSO FOR FULCRUM ULTRA TORQUE

This full set includes complete crank and bearing removal and installation tools for Campagnolo® and Fulcrum® Ultra Torque crank sets as well as for Campagnolo® Power Torque system.

GLOBAL	
code	Art.
623207	1626A

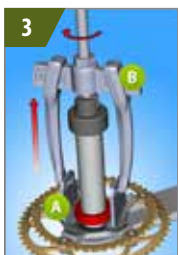

## CAMPAGNOLO AND FULCRUM ULTRA TORQUE BEARING REMOVAL AND INSTALLATION SET

Designed and built to install and remove the pressed bearing used on Campagnolo® and Fulcrum® Ultra-Torque cranks.

The bearing puller's forged arms and tapered edges securely pinch under the bearing while the heavy-duty plunger system "pulls" the bearing.

The installation tool precisely fits both the crank spindle and the press fit bearing to ensure proper installation. Just tap the bearing into place using the tool and a hammer.



GLOBAL	
code	Art.
621661	1626/2



## CAMPAGNOLO POWER TORQUE TOOL SET FOR CRANK REMOVAL AND BEARING INSTALLATION

Tool set 1626.1A is used together with 1626/2 Campagnolo Ultra Torque bearing removal and installation set. It's used to remove the Power Torque standard cranks and install & remove bearings on this crank.

GLOBAL	
code	Art.
623086	1626.1A



## CARTRIDGE BOTTOM BRACKET TOOL 20 TOOTH

- material: special tool steel, hardened and tempered
- for: Shimano®, ISIS®
- Use it together with the Unior 1/2" ratchet 190.1ABI

GLOBAL	
code	Art.
616068	1671.1/4



## CARTRIDGE BOTTOM BRACKET TOOL 8 TOOTH

- material: special tool steel, hardened and tempered
- for: Shimano®, XTR BB-950, Bontrager®, and Truvativ® (ISIS Drive® type) Use it together with the Unior 1/2" ratchet 190.1ABI

GLOBAL	
code	Art.
616069	1671.2/4



## BOTTOM BRACKET WRENCH BSA30

The tool has a professional double injected plastic handle, which enables strong grip and great comfort.

Wrench is used to install or remove BSA30 external cups.

Unior's BSA30 bottom bracket wrench works on the new BSA30 standard bottom brackets which you can find on Rotor®, DUB™, Zipp® and RaceFace® systems.

GLOBAL	
code	Art.
624037	2620/2BI



## #TheToolChris

Visit Unior Bike Tools YouTube or Facebook account to watch all the latest tool presentations by our friend and tool lover, The Tool Chris.





**H**

**CRANKSET TOOLS**

## CRANK PULLER WITH HANDLE



The crank puller is used for removing Shimano Octalink and ISIS cranks as well as for standard square spindle cranks. A strong handle enables quick and easy use. The product enables optimal efficiency and is suitable for both professionals and home users.

GLOBAL		NORTH AMERICA		dim
code	Art.	code	Art.	
623088	1661.3/4P	624918	1661.3/4P-US	165

## CRANK PULLER

- material: special tool steel, hardened and tempered
- surface finish: blacken

The crank puller is designed to remove standard square spindle cranks. With help of the included adapter other standards such as ISIS and Octalink cranks can also be removed.



GLOBAL		
code	Art.	dim
615529	1661/4	14mm

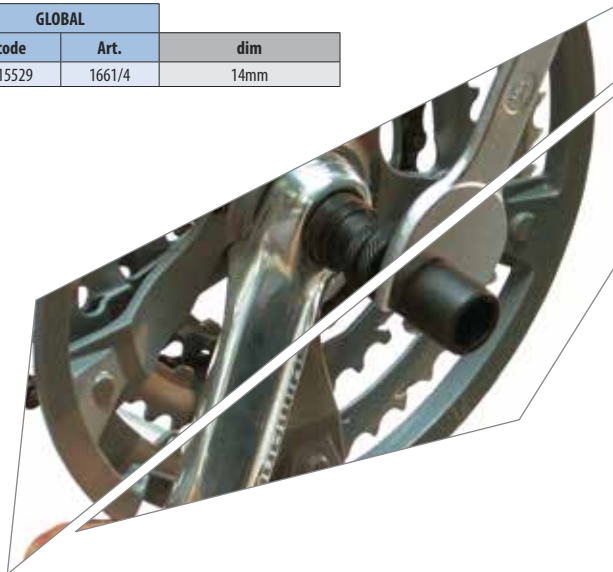



## TAPERED CRANK PULLER

- material: special tool steel, hardened and tempered

This crank puller is used to remove cranks with damaged inner threads when the crank cannot be removed with a normal crank puller.

GLOBAL	
code	Art.
619707	1662/4



## CRANK PULLER FOR SHIMANO® XTR FC-M970

- material: special tool steel, hardened and tempered

The crank puller is used for removing XTR FC-M970 cranks. To use, remove the plastic ring on the outside of the crank by using four pins on the left puller side. Unthread the nut on the inner crank side with the plastic clamp. Thread the puller with its right side into the crank and use a hex wrench to unthread the nut holding the crank. Now thread the puller, attached with its inner side to the crank nut until it is released from the crank. The product enables optimal efficiency and is suitable for both professionals and enthusiast mechanics.

GLOBAL	
code	Art.
619710	1664



## CRANK CAP TOOL METAL

Tool is used for removal and installation of Shimano plastic bolts that are used on the Hollowtech II cranksets.

Tool can be used by hand or with help of wrench size 13 mm.

Strong magnet in the back of the wrench, enables the tool to be stored on a convenient place.

GLOBAL	
code	Art.
623120	1609.1/2

## CRANK CAP TOOL

Works on Shimano Hollowtech II cranks.

Tool for installation and removal of the plastic adjusting cap on the Shimano HollowTechII cranks. The tool can be used by hand or with the 8 mm Hex wrench.

GLOBAL	
code	Art.
627017	1609.1



## RATCHET WRENCH



- material: special tool steel
- ergonomic heavy duty double component handle
- 75 - teeth
- interchangeable sockets: 14 mm and 15 mm

The design of the Unior ratcheting hub nut wrench enables working in hard to reach places. New shape enables higher torque, reduces physical effort and ensures a longer working life of the tool. Maximum torque is assured by the shape of the handle. The perfect ergonomic fit to the hand makes it easy and comfortable to work with.

The ratcheting nut wrench is made for tightening and loosening nuts of 14 and 15 mm dimensions. Special pins prevent the loss of the socket.

GLOBAL		NORTH AMERICA		dim
code	Art.	code	Art.	
615248	1621/1BI	624942	1621/1BI-US	14/15



## RATCHET WRENCH



- material: special tool steel
- 75 - teeth
- ergonomic heavy duty double component handle

The ratchet has an interchangeable HX8mm screwdriver socket and 14mm socket. Both are used for crank nuts.

GLOBAL		NORTH AMERICA		dim
code	Art.	code	Art.	
616288	1621/1ABI	624943	1621/1ABI-US	HX8



## CHAIN RING TRUING FORK

- material: special tool steel, hardened and tempered

The tool is used for repairing minor damage on the front chain rings. The narrow opening is intended for truing a tooth, the broader for truing the crank spider.



GLOBAL	
code	Art.
619704	1667/2



## CHAINRING NUT WRENCH

- material: special tool steel, hardened and tempered
- surface finish: chrome plated according to ISO 1456:2009

The wrench is used for unscrewing and tightening of front chain ring nuts. The tightening starts with the broader part, and when the nut is sufficiently tightened, it finishes with the narrower part which is bent in order to enable more secure power transfer during the final tightening of the nut. When unscrewing the nut, the key is used in the reverse order.

The dimension of the hexagonal key opening is SW10. It enables unscrewing and tightening of nuts of this dimension, while at the same time it can be used to hang the key.



GLOBAL	
code	Art.
618415	1668/2





**PEDAL TOOLS**

**I**

**NEW!**

## PEDAL GENIE

Pedal Genie is used as a substitute for pedals while adjusting derailleurs on a bicycle without pedals. It's especially useful for building new bikes that usually come without pedals. The tool features a strong double injected handle, which enables comfortable and efficient grip. The Pedal Genie comes with two adapters that offer two different ways of use. Threaded version for more efficient work and a conical version for quick checks. Threaded part is designed to work on the drive-side crank only (9/16" x 20 tpi thread).



GLOBAL		NORTH AMERICA	
code	Art.	code	Art.
627328	2650/BI	627766	2650/BI-US



## PRO PEDAL WRENCH

- material: special tool steel, hardened and tempered
- surface finish: chrome plated according to ISO 1456:2009
- ergonomic heavy duty double component handle

The professional pedal wrench has two 15 mm openings set at offset angles to easily remove pedals regardless of the pedal axle position. The design and finish ensures durability, strength and precision. The extra long handle provides the leverage to remove even the tightest pedals. Of course there is a bottle opener included for the most difficult workshop activity.



GLOBAL		NORTH AMERICA		dim
code	Art.	code	Art.	
615537	1613/2BI	624961	1613/2BI-US	15



## DOUBLE ENDED PEDAL WRENCH

- material: chrome vanadium
- surface finish: chrome plated according to ISO 1456:2009

Pedal wrench is intended for quick, simple end effective assembly and disassembly of the pedals. Extremely long and slim body as well as specially designed jaw enable perfect adaptability to the pedals. Higher speed and safety by screwing and unscrewing the pedals compared to the traditional open end wrench ensures comfortable working without damage. The pedal wrenches are available in three different dimensions: 15 x 15 for pedals, while 15 x 17 and 15 x 9/16" for hubs.



GLOBAL		
code	Art.	dim
615011	1610/2	15X15
615012		15X17
615127		15X9/16





## PEDAL MOUNTING THREAD REPAIR AND INSERT KIT



No more problems with stripped pedal mounting threads on the cranks. With the help of our Crank Saver Kit you can repair stripped threads and save your beloved cranks.

First use reaming taps and create oversized 5/8"×24 TPI threads in the crank arms. Thoroughly clean the threads, then apply thread locker to the insert and install it into the crank arm. Finally, thread the pedal into the insert.





For detailed instructions on Crank Saver Kit usage and inserts installation check the video below.

### Kit includes:

- Left and right reaming tap 5/8"×24 TPI
- 10 pedal thread inserts for left crank arm
- 10 pedal thread inserts for right crank arm

Kit comes in the metal box with cut out SOS foam trays, so each of the pieces will be always in the right place..

GLOBAL		NORTH AMERICA		dim
code	Art.	code	Art.	
626979	1695MB1	626980	1695MB1-US	15

1695/4BI,  1695.1AL (5/8" x 24 TPI),  1695.1AR (5/8" x 24 TPI),  1695.4A (5/8L x 24),  1695.3A (5/8 x 24), 981K (3/8" x 321 x 198 x 54)

## TAP HANDLE

Tap handle is used with one of the cutting taps, for example the pedal tap 1695.1AR. Long handles enables precise and easy use.



GLOBAL		NORTH AMERICA	
code	Art.	code	Art.
623190	1695/4BI	624963	1695/4BI-US





## FRAME TAPS

- material: special tool steel

Its function is to restore rusted or restore damaged threads. Available in three different thread sizes.

The finish prevents external damage.

M10 - frame tap for derailleur hanger (616079) M5 - frame tap for water bottle, fender, rack bosses (616078) M3 - frame tap for rear wheel dropout alignment screws (616077)

GLOBAL		
code	Art.	dim
616077	1695	M3
616078		M5
616079		M10



## PEDAL TAPS

- material: special tool steel

Precise design and hardened to stay sharp. 1695.1 is used to restore existing pedal threads and is available in set (left and right).

GLOBAL		
code	Art.	dim
616080	1695.1	9/16 x 20 TPI



## PEDAL TAPS

- material: special tool steel

Precise design and hardened to stay sharp. 1695.2 is used for cutting new threads before inserting pedal thread inserts 1695.3 or 1695.4 and is available comes in set (left and right).

GLOBAL		
code	Art.	dim
616081	1695.2	16x1



## RIGHT PEDAL THREAD INSERT 10 PIECES SET

- material: special tool steel
- inner dimension: M14 x 1,25
- outer dimension: M16 x 1

Pedal thread inserts are used to replace damaged threads in cranks. They are used together with appropriate pedal taps and are available in 10 pcs sets.

GLOBAL		
code	Art.	dim
616082	1695.3	/10



## LEFT PEDAL THREAD INSERT 10 PIECES SET

- material: special tool steel
- inner dimension: M14 x 1,25
- outer dimension: M16 x 1

Pedal thread inserts are used to replace damaged threads in cranks. They are used together with appropriate pedal taps and are available in 10 pcs sets.

GLOBAL		
code	Art.	dim
616083	1695.4	/10



## LEFT PEDAL REAMER AND TAP

- material: special tool steel

Precise design and hardened to stay sharp. 1965.1AL is used for cutting new left threads before inserting left pedal thread inserts 1695.3L. Pedal tap 1695.1AL removes the old thread before making a new one, so no other tap is needed.

GLOBAL		
code	Art.	dim
616554	1695.1AL	5/8"X24



## RIGHT PEDAL REAMER AND TAP

- material: special tool steel

Precise design and hardened to stay sharp. 1695.1AR is used for cutting new right threads before inserting right pedal thread inserts 1695.3A. Pedal tap 1695.1AR removes the old thread before making a new one, so no other tap is needed.

GLOBAL		
code	Art.	dim
616553	1695.1AR	5/8"X24



## RIGHT PEDAL THREAD INSERT 10 PIECES SET

- material: special tool steel
- inner dimension: 9/16 x 20 TPI
- outer dimension: 5/8 x 24 TPI

Pedal thread inserts are used to replace damaged threads in cranks. They are used together with appropriate pedal taps and are available in 10 pcs sets.

GLOBAL		
code	Art.	dim
616551	1695.3A	5/8"X24



## LEFT PEDAL THREAD INSERT 10 PIECES SET

- material: special tool steel
- inner dimension: 9/16 x 20 TPI
- outer dimension: 5/8 x 24 TPI

Pedal thread inserts are used to replace damaged threads in cranks. They are used together with appropriate pedal taps and are available in 10 pcs sets.

GLOBAL		
code	Art.	dim
616552	1695.4A	5/8"X24

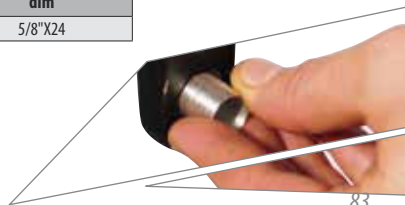



**J**

**CHAIN TOOLS**

## PRO CHAIN TOOL



- material: special tool steel, hardened and tempered
- ergonomic heavy duty double component handle
- also supports Campagnolo 11 speed

The Screw type chain tool is intended for both professionals and enthusiast users. The simple tightening of the spindle fits the chain pin with perfect precision and with its ergonomic design it is easy to use.

GLOBAL		NORTH AMERICA	
code	Art.	code	Art.
621662	1647/2ABI	624900	1647/2ABI-US



## CHAIN TOOL



The basic screw type chain tool is intended for home users. The simple tightening of the spindle fits the chain pin perfectly. The ergonomic design makes it precise and easy to use. The handle is plastic dipped and enables comfortable use. Works on all chains from 5 to 11 speeds.

GLOBAL		NORTH AMERICA	
code	Art.	code	Art.
623728	1647HOBBY/4P	624901	1647HOBBY/4P-US

## REPLACEMENT CHAIN PINS FOR PRO CHAIN TOOLS



- material: carbon steel

GLOBAL	
code	Art.
621734	1647.1/4A

## MINI CHAIN TOOL +



Our Mini Chain Tool + is ideal chain tool to take it with you out on the bike. Never mind the riding style or the drive train you use, this chain tool can cover anything from 5 to 11 speed and perform like our professional shop tools. Despite the small design, there is more it can do - its handle doubles in function as a valve core remover for schrader and presta valves.

GLOBAL	
code	Art.
627100	1647/SMINI

## MASTER LINK PLIERS



- tool can be used by professional or amateur mechanics

Master link pliers are for commonly used chains with master link, SRAM Powerlink or the KMC Missing Link. After chain use and due to mud and rust, it can be impossible to remove the master link with only your hands. With Unior 1720/2DP Master Link pliers, removal of the master link is easy.

GLOBAL		NORTH AMERICA	
code	Art.	code	Art.
623296	1720/2DP	624907	1720/2DP-US

## CHAIN RIVET PLIERS



- drop forged, entirely hardened and tempered
- surface finish: chrome plated according to ISO 1456:2009
- pin induction hardened

The chain rivet pliers have been developed to enable both professional and home mechanics to work quickly and safely on bicycle chains. Higher functionality and practicality are the advantages of the chain rivet pliers and with this unique design less physical effort is required to extract the rivet from the chain. Jobs will be performed quickly and comfortably without damage to the rivet or chain plate.. The ergonomic design enables single handed use.

GLOBAL		NORTH AMERICA	
code	Art.	code	Art.
615377	1640/1DP	624914	1640/1DP-US

## REPLACEABLE PIN FOR CHAIN RIVET PLIERS



GLOBAL	
code	Art.
605956	1640.1/4

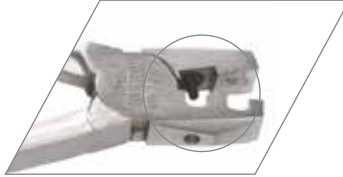

## PRO CHAIN WEAR INDICATOR



To alleviate poor shifting and uneven drive train wear, most manufacturers recommend chain replacement at or before 0,6% stretch. Now you can quickly and accurately determine the wear and stretch of any chain. Simply insert the chain checker's pins into two links, press the swing arm gauge tight, and then check the gauge window for an accurate reading.

GLOBAL	
code	Art.
617170	1643/4



## CHAIN WEAR INDICATOR

- made from precision, laser cut steel

Measurement: from 0 to 0,6% - no chain wear. from 0,7 to 1,2% the chain is worn out and it is necessary to replace it.

A worn chain shifts poorly and causes undue damage to the sprockets. The tool is a "go, no go" gauge designed to accurately indicate when a chain is worn out.



GLOBAL	
code	Art.
617171	1644/2

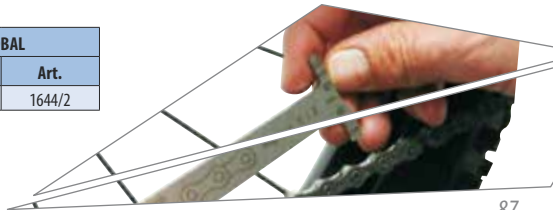





**K**

## CASSETTE & FREEWHEEL TOOLS

## CASSETTE WRENCH



- material: special tool steel, hardened and tempered
- surface finish: chrome plated according to ISO 1456:2009
- ergonomic heavy duty double component handle

The freewheel remover is intended for all types of sprocket including cassette types. It is useful for freewheel with 11 and 12 teeth.

Code 622881 is used for freewheel with 13 an 14 teeth.

GLOBAL		NORTH AMERICA		dim
code	Art.	code	Art.	
617235	1670/2BI	624931	1670/2BI-US	11 / 12
622881		624967		13 / 14

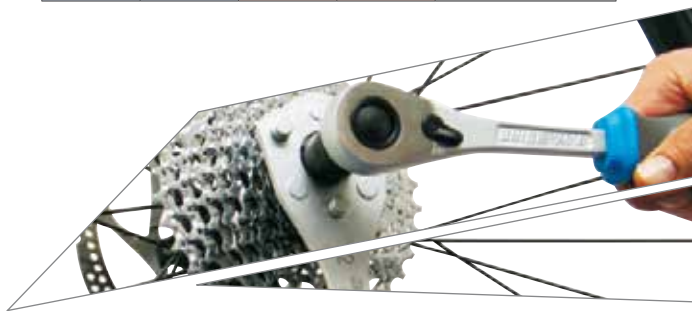

## CHAIN WHIP



- material: special tool steel, hardened and tempered
- surface finish: chrome plated according to ISO 1456:2009
- chain Whip: 1/2" x 1/8"

The freewheel remover is designed for removal of single speed freewheels, which are broader than multi speed freewheels. The chain fits precisely to the freewheel teeth and thus enables effective work without slipping or damaging the sprockets. An added retaining spring is a special feature distinguishing this tool from similar products.

GLOBAL		
code	Art.	dim
619589	1659/2	1/2"x1/8"

## CHAIN WHIP



- material: special tool steel, hardened and tempered
- surface finish: chrome plated according to ISO 1456:2009
- chain Whip: 1/2" x 3/32"

The freewheel remover is intended for all types of sprockets including cassette types. It works effectively and precisely without slipping or damaging the sprockets. An added retaining spring is a special feature compared to similar products.

GLOBAL		
code	Art.	dim
615528	1660/2	1/2"x3/32"

## UNIVERSAL FREEWHEEL REMOVER



Changing sprockets on threaded hubs can be a time consuming operation. The 1722/2BI is a unique tool for removal of different standard sprockets from a threaded hub.

On most of the sprockets you can find two or four shallow openings where you can use different tools for removal of the sprocket. Problems occur when the complete system is old and rusted. With Unior's 1722/2BI you can firmly grab the complete sprocket from two sides, turn the spindle and fix firmly. The spindle and the side bushings on the tool create a strong grip. By turning the tool counter clockwise you can unscrew the sprocket. For more explanation, see the instructions and video sections.

GLOBAL		NORTH AMERICA	
code	Art.	code	Art.
623473	1722/2BI	624937	1722/2BI-US

## SPROCKET WEAR INDICATOR

- for HG and IG sprockets
- material: special tool steel, hardened and tempered
- surface finish: chrome plated according to ISO 1456:2009

The sprocket wear indicator is used to determine the condition rear sprockets. It can be used to check 12 to 21 tooth sprockets. Procedure: The chain is put on the sprocket and the tool placed with its round end between two teeth on the upper sprocket side. The last chain link is moved away from the sprocket and a force of 100 N or 10 kg is applied to the tool in the direction of sprocket rotation. Now the last chain link is moved towards the sprocket. If it skips easily to the cog the sprocket is in a good condition and will function flawlessly even with a new chain. However, if the last chain link gets stuck on the tip of the neighbouring tooth or if we have to force it to skip on the cog, the sprocket is worn out and should be replaced. In case the chain falls off the cog when applying force, the sprocket is heavily worn out and a replacement is overdue.

GLOBAL		NORTH AMERICA		dim
code	Art.	code	Art.	
619717	1658/2P	624954	1658/2P-US	HG-IG

## CASSETTE LOCKRING WRENCH WITH GUIDE

Wrench for rear sprocket with handle is used for Shimano®, SRAM®, Sun Race®, Suntour® and other cassette sprockets, like the key nr. 1670.7. Fixed handle enables easier use because no additional tools for gripping the key are necessary. The two-component sleeve on the handle fits the hand exactly and enables a perfect grip of the key.

GLOBAL		NORTH AMERICA		dim
code	Art.	code	Art.	
617908	1670.8/2BI	624932	1670.8/2BI-US	350

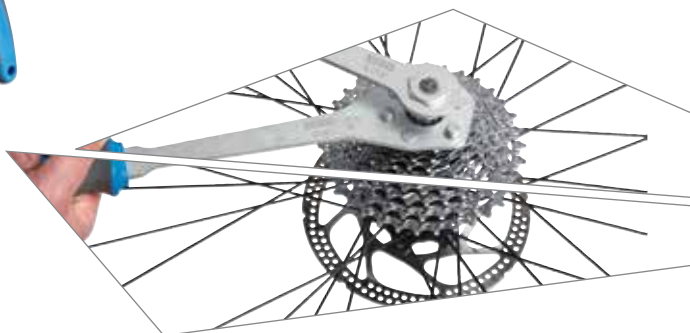

## CASSETTE & FREEWHEEL TOOLS



1670.1/4



1670.2/4



1670.3/4



1670.4/4



1670.5/4



1670.6/4



1670.7/4



1670.9/4

GLOBAL		
code	Art.	Used for:
616062	1670.1/4	For: Shimano®, SRAM® and Sachs Aris®, Sun Race®
616063	1670.2/4	For: Suntour®
616064	1670.3/4	For: Suntour®
616707	1670.4/4	Freewheel remover Campagnolo®
616065	1670.5/4	Shimano®, SRAM®, Sun Tour®, Chris King® and Sun Race® and others.
616066	1670.6/4	BMX®
616067	1670.7/4	Freewheel Remover with guide pin for Shimano®, SRAM® Sun Race®, Suntour® and others.
625615	1670.9/4	Cassette locking tool with 12mm guide pin



## PRO SOCKET HANDLE 1/2"



GLOBAL		NORTH AMERICA		dim
code	Art.	code	Art.	
627084	190.8/2BI	627085	190.8/2BI-US	250

## 2 IN 1 POCKET SPOKE AND CASSETTE LOCKRING TOOL

- material: special tool steel, hardened and tempered
- surface finish: blacken to standard DIN 50938

The wrench is the basic working tool for cyclists extended tours. To change broken spokes on the right side of the rear wheel, the cassette has to be removed first. Firstly remove the rear wheel, then fit the tool onto the freewheel nut. Replace the rear wheel, so that the square edge of the tool presses to the frame or derailleur hanger. After that, push the pedals in the forward direction and loosen the freewheel nut. Remove the cassette and replace the broken spoke. In order to prevent the possibility that the paint on the bicycle frame is damaged, a protective plastic plate should be inserted between the key and the frame.

GLOBAL	
code	Art.
616758	1669/4

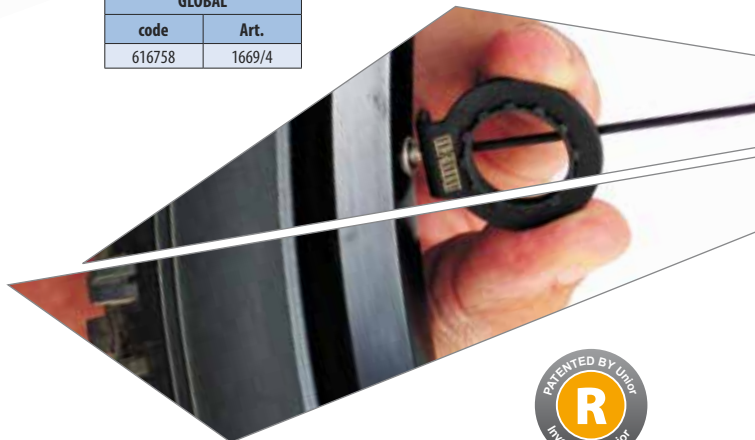



L

## BRAKE TOOLS

## DISC BRAKE PISTON SPREADER



- tool can be used by professional or amateur mechanics
- bike brake disc spreader
- tool is bended under 30°
- use for changing bike brake pads

### Using:

1. remove wheel from bike
2. insert spreader between brake pads, pushing tool till the both brake pistons are back in the caliper body
3. remove the spreader and old brake pads
4. insert new brake pads
5. reinstall wheel back on

GLOBAL		NORTH AMERICA	
code	Art.	code	Art.
621889	1750/2BI	624904	1750/2BI-US

## ROTOR TRUING FORK



- material: special tool steel, hardened and tempered
- surface finish: chrome plated according to ISO 1456:2009

The tool is designed to repair minor damage on brake rotors. It features two different sloth depths to choose from.

GLOBAL		NORTH AMERICA	
code	Art.	code	Art.
619716	1666/2DP	624905	1666/2DP-US





NEW!



## 2-FOR-1 DISC BRAKE TOOL

- material: special tool steel, hardened and tempered
- surface finish: chrome plated according to ISO 1456:2009

Unique design of this tool combines two tools in one – standard disc brake pad spreader and rotor truing fork. The slot allows you to true the rotor back in place and save you thumbs from getting cut on the sharp edges of the rotor. The conically shaped tip of the tool is designed to slide between the pads inside the caliper and spread the pads, pushing pistons back in to the caliper. 2-for-1 Disc Brake Tool is the tool to have at hand in any home garage, when out riding or traveling.

**Warning: Always make sure disc calipers and disc rotor have cooled down before you start working on them.**

GLOBAL		NORTH AMERICA	
code	Art.	code	Art.
627086	1757/ZDP	627087	1757/ZDP-US

## BOTTOM BRACKET WRENCH 16 NOTCH

- material: special tool steel, hardened and tempered
- surface finish: chrome plated according to ISO 1456:2009
- ergonomic heavy duty double component handle

The wrench is used to remove and install Shimano® Hollowtech II, Campagnolo® Ultra-Torque and Power Torque, Race Face®, FSA®, SRAM®, Truvativ®, Chris King® bottom brackets as well as many and others. Small wrench is included for removal and installation of Shimano plastic bolts that are used on the Hollowtech II cranksets. The 1609/2BI wrench also fits on the external centerlock disc nut.



GLOBAL		NORTH AMERICA	
code	Art.	code	Art.
615536	1609/2BI	624903	1609/2BI-US

## WRENCH FOR SAINT BRAKE DISC NUT

- material: special tool steel, hardened and tempered
- surface finish: chrome plated according to ISO 1456:2009
- ergonomic heavy duty double component handle

The wrench is intended to install and remove Shimano Saint brake disc. The wrench opening is fully adjusted to the brake disc nut and the body is bent, which enables high-quality and fast work. The two-component sleeve on the handle fits exactly to the hand and enables the maximum power transfer to unscrew and tighten the disc.



GLOBAL	
code	Art.
618413	1663/2BI

## OFFSET OPEN RING WRENCH



- material: chrome vanadium
- drop forged, entirely hardened and tempered
- surface finish: chrome plated according to ISO 1456:2009
- profile up to dimension 12x14 is 6 point, from 17x19 to 30x32 is 12 point

In industry and repair shops specializing in hydraulic and pneumatic installations This wrench helps working on joints where the use of standard ring wrench is impossible due to the nature of the job (ex. unions on steel cables, hydraulic and water pipes and on valves etc).

GLOBAL		
code	Art.	dim
612701	183/2	8x10

## INNER WIRE PLIERS WITH SAFETY LOCK



- material: special tool steel, hardened and tempered
- surface finish: chrome plated according to ISO 1456:2009
- double plastic dipped handles

The basic function of the inner wire pliers is to tension brake and derailleur steel cables. It is used for holding the inner cable and pulling it out of the housing. The safety lock is activated with a thumb push. The pliers can now be released and the cable fixed. The lock is automatically released by squeezing handles together. The additional safety lock enables easier, faster and more comfortable use.

GLOBAL		NORTH AMERICA	
code	Art.	code	Art.
619719	1642.1/2P	624917	1642.1/2P-US

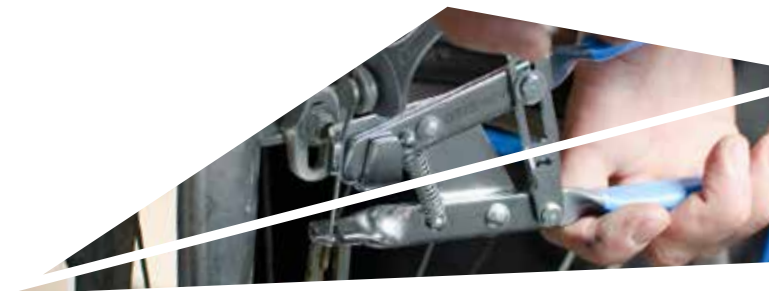



**M**

## FRAME AND FORK TOOLS

## BOTTOM BRACKET TAPPING TOOL BSA



- ideal tool for fixing bottom bracket threads on the frame or removes excess paint or dirt from threads
- magnetic handle eases assembly of the tool
- ergonomic heavy duty double component handle
- BSA standard - left & right thread tap 1.3/8 × 24 TPI

### The set contains:

Reamer's magnetic handle 1695.1/4BI or 1695.1/4BIUS.

Reamer holder for 1697.2/4.

Left & right tap BSA 1.3/8 × 24 TPI.

GLOBAL		NORTH AMERICA		dim
code	Art.	code	Art.	
626474	1697	626475	1697-US	1.3/8 x 24 tpi

## SET OF ADAPTER AND TAPS 1697



Set is compatible with magnetic handle 1695/4BI for reamers and taps.

### The set contains:

- 2 adapters for taps BSA
- Left & right tap BSA 1.3/8 × 24 TPI

GLOBAL	
code	Art.
626487	1697.3

## ADAPTER FOR TAPS BSA



Adapter is compatible with taps BSA 1697.1 and magnetic handle 1695/4BI for reamers and taps. Slot on the top of the adapter enables quick and easy assembly of the tool together with the handle for reamers and taps 1695/4BI.

GLOBAL	
code	Art.
626467	1697.2/4



## TAPS BSA

- material: special tool steel
- Left and right taps available in set for article 1697.

GLOBAL		
code	Art.	dim
617310	1697.1	1.37"24tpi (BSA)

## GUIDE FOR TAPS 1697.1 AND 1698.1

Guide threads into adapter to hold taps in place and centers the tool during usage. Guide is compatible with both 1697.1 and 1698.1 taps and 1697.2/4 and 1698.2/4 adapters. It consists of male and female part with a precise fit.



GLOBAL	
code	Art.
627325	1697.4

## BOTTOM BRACKET TAPPING TOOL ITAL 1698

- Ideal tool for fixing bottom bracket threads on the frame or removes excess paint or dirt from threads
- Magnetic handle eases assembly of the tool
- ergonomic heavy duty double component handle
- ITA standard –two thread taps M36 × 24 TPI

### The set contains:

- Reamer's magnetic handle 1695.1/4BI or 1695.1/4BIUS
- Reamer holder for 1698.2/4
- Two ITAL thread taps M36 × 24 TPI



GLOBAL		NORTH AMERICA		dim
code	Art.	code	Art.	
626472	1698	626473	1698-US	36x24tpi

## SET OF ADAPTER AND TAPS 1698

Set is compatible with magnetic handle 1695/4BI for reamers and taps.

### The set contains:

- 2 adapters for taps ITAL
- 2 taps ITAL 36 × 24 TPI

GLOBAL	
code	Art.
626486	1698.3



## ADAPTER FOR TAPS ITAL



Adapter is compatible with taps ITAL 1698.1 and magnetic handle 1695/4BI for reamers and taps. Slot on the top of the adapter enables quick and easy assembly of the tool together with the handle for reamers and taps 1694/4BI.

GLOBAL	
code	Art.
626466	1698.2/4

## TAPS ITAL



- material: special tool steel
- Left and right taps available in set for product no. 1698.

GLOBAL		
code	Art.	dim
617590	1698.1	ITAL(36X24)tpi

## BOTTOM BRACKET FACING TOOL BSA & ITAL 1699



- Tool is used to restore or prepare the surface of bottom bracket shell
- Magnetic handle eases assembly of the tool
- ergonomic heavy duty double component handle
- Precision manufactured tool
- Reamer frame guide BSA 1699.4BSA with tool 1699.5/4P

### The set contains:

- Reamer's magnetic handle 1695.1/4BI or 1695.1/4BIUS
- Reamer body 1699.2/4
- Reamer 1699.1
- Reamer frame guide BSA 1699.4BSA with tool 1699.5/4P

### Option

- Reamer frame guide ITA 1699.4ITA

GLOBAL		NORTH AMERICA		dim
code	Art.	code	Art.	
626476	1699	626477	1699-US	1.37x24tpi(BSA), 36x24tpi(ITAL)

## BOTTOM BRACKET REAMER TOOL FRAME BSA & ITA



Tool frame is compatible with bottom bracket reamer 1699.1 and magnetic handle for reamers and taps 1695/4BI. Slot on the top of the adapter enables quick and easy assembly of the tool together with the handle for reamers and taps 1694/4BI.

GLOBAL	
code	Art.
626468	1699.2/4

## BOTTOM BRACKET REAMER



- material: special tool steel
- compatible with BSA & ITAL standard

GLOBAL	
code	Art.
617592	1699.1

## BOTTOM BRACKET FACING TOOL GUIDE ITAL



GLOBAL	
code	Art.
626469	1699.4ITA

## BOTTOM BRACKET FACING TOOL GUIDE BSA



- Guide ensures precise centering of the bottom bracket reamer.
- Threads into the frame with the wrench for guide 1699.5/4P.

GLOBAL	
code	Art.
626470	1699.4BSA



## TOOL FOR TAPS GUIDE FOR 1699

Wrench is used to thread bottom bracket facing tool into the frame and is compatible with BSA & ITAL guides. The handle of the wrench is plastic dipped for comfort.

GLOBAL	
code	Art.
626471	1699.5/4P

## HEAD TUBE FACING TOOL

Frame preparation is the key to the perfect alignment and ultimate performance of your headset. Get the perfect fit of the headset with the edging of the head tube. With this tool, you can also remove the excess of the paint or repair the damaged head tube.

### The set contains:

- Reamer's magnetic handle 1695.1/4Bl or 1695.1/4BIUS
- Reamer frame for head tube 1694.2/4
- Cone guide
- Head tube reamer for 1694 – 1.1/8
- Compression spring and nut



GLOBAL		NORTH AMERICA		dim
code	Art.	code	Art.	
626479	1694	626480	1694-US	1.1/8"

## HEAD TUBE FACING TOOL FRAME

Reamer frame is compatible with reamer 1694.1 and magnetic handle for reamers and taps 1695/4Bl. Slot on the top of the adapter enables quick and easy assembly of the tool together with the handle for reamers and taps 1694/4Bl.

GLOBAL	
code	Art.
626463	1694.2/4







## HEAD TUBE REAMER

- material: special tool steel
- reamer for head tube with diameter 1.1/8"

GLOBAL		
code	Art.	dim
617824	1694.1	1 1/8"



## HANDLE FOR REAMER AND TAPS

Handle is ergonomically shaped and made of heavy duty two component material. Its speciality is the magnetic tooth, which enables quick and easy assembly of the tool and at the same time allows you to use a single handle on several different tools.

### Handle is compatible with:

- Bottom bracket tapping tool BSA 1697
- Bottom bracket tapping tool ITAL 1698
- Bottom bracket facing tool BSA & ITAL 1699
- Head tube facing tool 1694
- Set of adapters and taps BSA 1697.3
- Adapter for tap BSA 1697.2/4
- Set of adapters and taps ITAL 1698.3
- Adapter for tap ITAL 1698.2/4
- Bottom bracket reamer tool frame BSA & ITA 1699.2/4
- Head tube facing tool frame 1694.2/4

GLOBAL		NORTH AMERICA	
code	Art.	code	Art.
626464	1695.1/4BI	626465	1695.1/4BI-US

## HEADSET PRESS



- material: special tool steel

This tool accurately presses headset cups 1", 1-1/8", 1-1/4" and 1-1/2" into head tubes. In addition it has a longer spindle for BMX headsets with larger tubing. This precision made tool enables work without damage.

GLOBAL		
code	Art.	dim
616290	1680/4	1"; 1.1/8"; 1.1/4"; 1.1/2"



## HEAD SET CUP REMOVER



- material: special tool steel
- surface finish: blacken to standard DIN 50938

The head set cup remover makes removal of cups 1", 1-1/8" and 1-1/4" from the frame easy.

GLOBAL		
code	Art.	dim
616291	1681/4	1", 1.1/8", 1.1/4"



## HEAD SET CUP REMOVER, 1 ¼", 1 ½"

- material: special tool steel
- surface finish: blacken to standard DIN 50938

The head set cup remover makes removal of cups 1-1/4" and 1-1/2" from the frame quick and easy.

GLOBAL		
code	Art.	dim
619705	1681.1/4	1.1/4"; 1.1/2"



## CROWN RACE SETTER

- material: special tool steel
- surface finish: blacken to standard DIN 50938

The crown race setting system is intended for crown race installation on the steerer tube to fit 1", 1-1/4", 1-1/8", 1-1/2" diameters. The inserts are interchangeable. This tool enables quick and efficient work.

GLOBAL		
code	Art.	dim
620255	1683/4A	1"; 1.1/8"; 1.1/4"; 1.1/2"



## CROWN RACE PULLER



- material: special tool steel, hardened and tempered
- surface finish: blacken to standard DIN 50938

The puller is a tool for quickly and precisely removing the headset crown race from 1", 1-1/8", 1-1/2" or 1-1/4" suspension or rigid front fork. To use, place the puller bush onto the front fork race and fix it by turning the nut. Turn the spindle attached to the steering column to pull the crown race from the fork. The product enables efficient race removal without the use of a hammer. It is intended for both professionals and enthusiasts.



GLOBAL		NORTH AMERICA	
code	Art.	code	Art.
620195	1614/4BI	624941	1614/4BI-US



## BALL RACE REMOVER



- material: special tool steel
- surface finish: blacken to standard DIN 50938

This tool is used for removal of headsets of older bike models. To remove the ball bearing cups, tap on the tool with hammer.

GLOBAL		
code	Art.	dim
615527	1616/4	1", 1 1/8", 1 1/4"

## FORK THREADING TOOL

- material: special tool steel
- ergonomic heavy duty double component handle

The fork threading tool is designed for cutting new threads and for chasing existing threads on steerer tubes that are not chromed. Made from quality steel and designated for long life use. Use the tool on the steerer tube under 90° angle. When cutting threads, use cutting grease. The ergonomic design of the handle ensures optimal force transmission and effective work.



GLOBAL		NORTH AMERICA		dim
code	Art.	code	Art.	
616074	1696	624968	1696-US	1"
619633		624969		1 1/8"

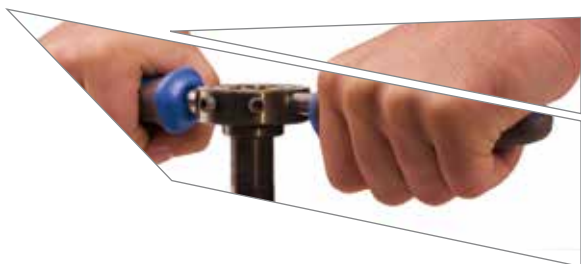

## TAP FOR FORK THREADING TOOL

- material: special tool steel
- to be used with tool 1696



GLOBAL		
code	Art.	dim
616075	1696.1	1"

## TAP FOR FORK THREADING TOOL

- material: special tool steel
- to be used with tool 1696



GLOBAL		
code	Art.	dim
617898	1696.2	1 1/8"

## OFFSET SINGLE SIDED CONE WRENCH



- material: special tool steel, hardened and tempered
- surface finish: chrome plated according to ISO 1456:2009
- double plastic dipped handles

The design of the offset cone wrench enables working in difficult hard to reach places. This unique design is suitable for assembly and disassembly of nuts on Sun Tour headsets. It is intended to be used together with the single sided cone wrench, product no. 1617/2DP. The new design enables higher torque with reduced force.

GLOBAL		NORTH AMERICA		dim
code	Art.	code	Art.	
615372	1618/2DP	624939	1618/2DP-US	36

## STAR NUT SETTER



- material: special tool steel
- surface finish: blacken to standard DIN 50938

The threadless nut setter is used to install the star fangled nut found on 1" and 1-1/8" threadless headset systems. It is intended for both professionals and home users.

GLOBAL		
code	Art.	dim
616292	1682/4	1", 1.1/8"

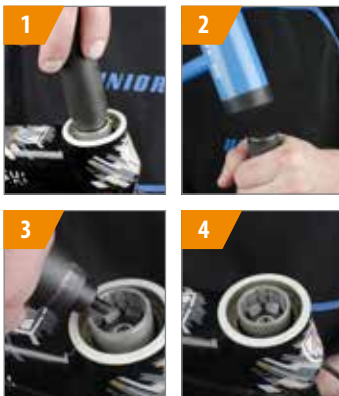

## STAR NUT GUIDE



- material: special tool steel
- surface finish: phosphated to standard ISO 9717

The guide is designed for guiding the threadless nut setter when installing star nuts found on 1" and 1-1/8" threadless headset systems. It is intended for both professionals and enthusiasts.

GLOBAL		
code	Art.	dim
619618	1682.1/4	1", 1 1/8"

## STEERER TUBE CUTTING GUIDE



- material: special tool steel
- for dimensions: 1", 1-1/4", 1-1/8", 1-1/2"

When the steering tube on a new fork is longer than necessary, it needs to be shortened to the correct length. The cutting guide enables an even and precise cut of the steerer tube with dimensions 1", 1-1/4", 1-1/8", 1-1/2". Clamp the fork into the cutting rail, the cut must be positioned exactly on the opening of the guide itself. Lightly tighten the screw. Install the cutting guide along with the fixed fork to the vice on the work bench. Saw the steering tube by means of a saw (product no. 750) through the opening in the guide. The compact and precision housing, made in a compact does not leave scratches on the steering tube.

The 1604/2PLUS enables mounting of the measuring gauge item 1604.1/2PLUS, which enables fast and precise determination of steering tube length desired after the cut.

GLOBAL	
code	Art.
623417	1604/2PLUS

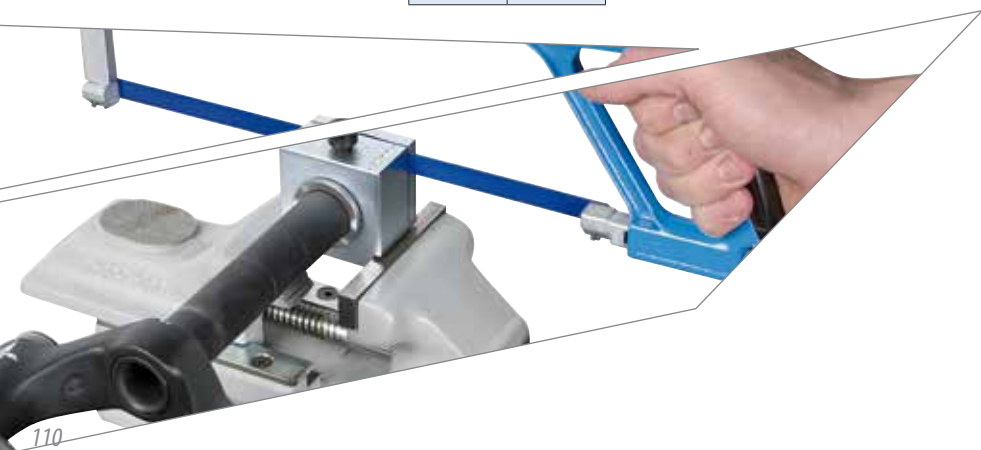



## GAUGE FOR STEERER TUBE CUTTING GUIDE

Measuring gauge item 1604.1/2PLUS fits onto the steerer cutting guide 1604/2PLUS and enables fast and precise determination of steering tube length desired after the cut.

GLOBAL	
code	Art.
623418	1604.1/2PLUS



## TUBE CUTTER

- cutting wheels and rollers from special steel, oil hardened
- lacquered housing
- spare cutter in handle
- replaceable parts: cutting wheels and rollers

GLOBAL		
code	Art.	dim
601104	360/6	3 - 32



## INTERNAL - EXTERNAL REAMER

- elimination of burrs on interior and exterior tube edges
- plastic housing
- cutting blades from special tool steel, oil hardened

GLOBAL		
code	Art.	dim
601112	363	4 - 36



## DERAILLEUR HANGER ALIGNMENT TOOL

- material: special tool steel, the pipe is made of construction steel

The derailleur hanger and the rear derailleur, must be parallel to the rear wheel which enables smooth running of the chain and fast and efficient shifting.

If the bicycle falls on the right side, damage to the rear derailleur and derailleur hanger often occurs. The result of this damage causes misshifting in the rear derailleur. When performing repair work, first the rear wheel must be centered because an aligned rear wheel is the basis for the adjustment of the derailleur hanger. The tool is easy to use and very precise. It is used to check the alignment of the rear derailleur hanger and the wheel, and to align the hanger if necessary.

When performing repair work, first the rear wheel must be centered because an aligned rear wheel is the basis for the adjustment of the derailleur hanger.

The tool is easy to use and very precise. It is used to check the alignment of the rear derailleur hanger and the wheel, and to align the hanger if necessary.

### How to use the tool:

Mount the control to the derailleur hanger. Move the slider along with the measuring gauge towards the rim and position it in such a way that the gauge only lightly touches the rim. Perform the check by moving the tool to different positions on the rim. If the derailleur hanger is parallel to the wheel, the measuring gauge will keep the same distance from the rim on all positions. If distance between the measuring gauge and rim changes in any direction, the hanger has to be aligned. Repeat the procedure until the distance of the gauge and the rim is the same in all positions.



GLOBAL		
code	Art.	dim
617587	1602/2	430

## DROPOUT ALIGNMENT GAUGES

- material: special tool steel, hardened and tempered
- surface finish: blacken to standard DIN 50938

To use, remove the wheel and insert the tool into the frame. This tool is used for the alignment of the rear triangle and dropouts.



GLOBAL		
code	Art.	dim
618412	1692/4	309.5



**BEARING TOOLS**

**N**

## UNIVERSAL BEARING PRESS



Unior's 1721 universal bearing press set enables installation of bearings on most of the frames and components.

Set includes spindle with two threaded handles, adapters for following standard bearings: 608, 1526, 6000, 6001, 6802, 6803, 6804, 6805, 6900, 6901, 6902, 6903, R6, 28x17 (Hope), BB30, all Press-fit standards and two different sized plastic coated adapters, to protect carbon surfaces during bearing installation.

One of the threaded handles includes a quick release system for quick and easy use.

All items are organized in a compact two layer SOS foam storage box.

GLOBAL	
code	Art.
623301	1721



## INNER BEARING PULLER

- material: special tool steel
- drop forged, entirely hardened and tempered
- surface finish: chrome plated according to ISO 1456:2009
- ergonomic heavy duty double component handle

Set includes 6 pcs of arm for inner bearing dimensions 6.5-8,10-12, 12-15, 17-20, 22-28, 30-36. It is used for pulling different types of bearings. The bearing is gripped from the inside side and pulled out.

The bearing is extract with a 1 kg weight.



GLOBAL		NORTH AMERICA	
code	Art.	code	Art.
622587	689/2BI	626629	689/2BI-US

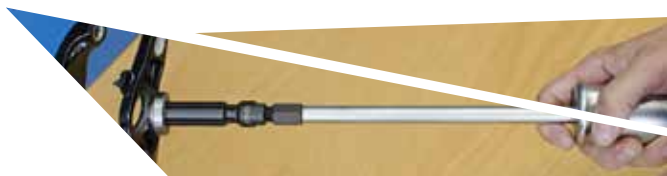



**SUSPENSION TOOLS**

**0**

## SUSPENSION SERVICE SET







### The set contains:

- Bushing extractor set sizes 12 mm and 12.7 mm
- Fork seal installation tool for fork sliders sizes 30, 32, 34, 35/36 and 40 mm
- Hex wrenches sizes 3/64", 1/16", 1.5, 2, 2.5 and 3
- 1/2" sockets sizes 10, 15, 26, 27, 28, 30
- Reversible ratchet
- Strap wrench
- Waterpump box joint pliers

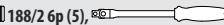
Unior's suspension service set includes the most popular professional tools for servicing forks and shocks, all nicely arranged in a SOS tool tray and stored in a compact box.

GLOBAL		
code	Art.	dim
624041	1704	27

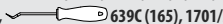
 188/2 6p (5),  188.2/2BI (1/4"),  190/1 6p (10, 15),  190.1/1ABI (1/2"),  220/3 (3/64", 1/16", 1.5, 2, 2.5, 3), 253/2DP (2,3 x 2,8),  449/1PYTHON (300),  639C (165), 1701/5, 1702 (30, 32, 34, 35/36, 40), 1705/2DP, 1783/1 6P (24, 26, 27, 28, 30, 32)
--

## FORK SEAL DRIVER TOOL



The Tool is intended for installation of fork dust seals on front fork suspension. Based on the seal dimension the appropriate version of the tool is used - 30mm, 32mm, 34mm, 35mm/36mm or 40mm. The Tool is made from reinforced plastic and does not damage the seal or the fork housing.

GLOBAL		
code	Art.	dim
623024	1702	32
623025		34
623026		35/36
623027		40
624366		30



## SUSPENSION TOP CAP SOCKET



- material: chrome molybdenum
- drop forged, entirely hardened and tempered
- surface finish: chrome plated according to ISO 1456:2009

GLOBAL		
code	Art.	dim
625716	1783/1 6p	23
624714		24
624215		26
624216		27
624217		28
624218		30
624219		32



## SUSPENSION WRENCH WITH STRAP



- material: chrome vanadium
- drop forged, entirely hardened and tempered
- surface finish: chrome plated according to ISO 1456:2009

Tool has a double plastic dipped handle for great comfort.

Tool is used for servicing bicycle suspension. With its smooth rubberized strap you can grab any kind of smooth and sensitive surface, like shock or fork sliders.

GLOBAL		NORTH AMERICA	
code	Art.	code	Art.
624367	1705/2	625105	1705/2DP-US

## HEXAGONAL WRENCH FOR SUNTOUR AND RST FORKS



GLOBAL		
code	Art.	dim
623259	1703/2	5x6x10



## SHOCK BUSHING EXTRACTOR SET

Tool is used for removing old bushings from the rear shock.  
 With use of this tool and a vice, removal of the bushing is incredibly easy.  
 Tool supports bushings removal with diameter 12 mm and diameter 12,7 mm.

GLOBAL		
code	Art.	dim
623006	1701/5	12 - 12.7



## EXTERNAL LOCK RINGS PLIERS, STRAIGHT

- material: special tool steel
- drop forged, entirely hardened and tempered
- head polished
- surface finish: chrome plated according to EN12540:2000
- tips black finish
- double plastic dipped handles
- made according to standard DIN 5254 form A

GLOBAL		NORTH AMERICA		dim
code	Art.	code	Art.	
621187	532PLUS/1DP	625125	532PLUS/1DP-US	140 (3-10mm)



## EXTERNAL LOCK RINGS PLIERS, BENT

- material: special tool steel
- drop forged, entirely hardened and tempered
- head polished
- surface finish: chrome plated to standard ISO 1456:2009
- tips black finish
- made according to standard DIN 5254 form B
- double plastic dipped handles

GLOBAL		NORTH AMERICA		dim
code	Art.	code	Art.	
621195	534PLUS/1DP	625126	534PLUS/1DP-US	140 (8-13mm)



## INTERNAL LOCK RINGS PLIERS, STRAIGHT

- material: special tool steel
- drop forged, entirely hardened and tempered
- head polished
- surface finish: chrome plated according to EN12540:2000
- tips black finish
- double plastic dipped handles
- made according to standard DIN 5256 form C

GLOBAL		NORTH AMERICA		dim
code	Art.	code	Art.	
621203	536PLUS/1DP	625127	536PLUS/1DP-US	140 (8-13mm)



## INTERNAL LOCK RINGS PLIERS, BENT

- material: special tool steel
- drop forged, entirely hardened and tempered
- head polished
- surface finish: chrome plated to standard ISO 1456:2009
- tips black finish
- double plastic dipped handles
- made according to standard DIN 5256 form D

GLOBAL		NORTH AMERICA		dim
code	Art.	code	Art.	
621211	538PLUS/1DP	625128	538PLUS/1DP-US	140 (8-13mm)



## SET OF LOCK RINGS PLIERS PLUS IN BAG



GLOBAL		
code	Art.	dim
621623	539PLUS/1DPCT	140 (3-13mm)

## AWL WITH ROUND, DOUBLE BENT BLADE



GLOBAL		
code	Art.	dim
617775	639C	165

## AWL SET



GLOBAL		
code	Art.	dim
617777	639PB	/45



**WHEEL TOOLS**

**P**





## MASTER WHEEL BUILDING KIT

GLOBAL		
code	Art.	dim
623441	1754	16

1560	15	1
1751/2 (1,2),  1751/2Q (3,35 x 3,35), 1751/2T (1,3), 1629 (357,5),  629TBI (5,5),  193N (5,5),  1633/2P (4 x 4,4),  1634/2P (4,3 x 4,4),  1636/2P (5 x 5,5), 1635/2P,  1635/2AP,  1630/4DTPR (TX 20), 1630/2P (3,3, 3,45),  1632,  981PBS3 (346 x 292 x 62)		



## NIPPLE DRIVER

A must have wheel building tool. Rotating handle and the guide shape enables you to quickly screw the nipple onto the spoke. It supports standard shape nipples.

GLOBAL	
code	Art.
623297	1751/2



## INVERTED SQUARE NIPPLE DRIVER

Unior 1751/2Q is used for both normal and inverted nipples with 3.2 mm square head. The 90mm long stem enables work with deep aero rims as well as with all the normal rims. The professional metal handle gives perfect grip.

GLOBAL	
code	Art.
623298	1751/2Q

## NIPPLE INSERTION TOOL

The Unior nipple assembly tool is your best friend when building wheels. Its firm spring enables you, to simply attached the nipple and screw it through a double wall rim on the spoke. This way, you avoid losing nipples between the walls of the rim. The spring is interchangeable, item 1751.1/7T.



GLOBAL	
code	Art.
623299	1751/2T

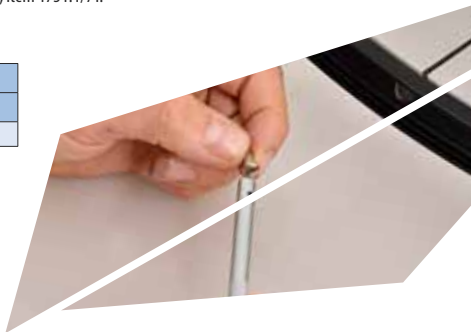

## DT SWISS® SQUORX NIPPLE SOCKET SCREWDRIVER

1751/2DT screwdriver is used for DT Swiss® SQUORX nipples with torx shaped top head. The 80mm long stem enables work with deep aero rims as well as with all the normal rims. The professional metal handle gives perfect grip. Unior 1751/2Q is used for both normal and inverted nipples with 3.2 mm square head. The 90mm long stem enables work with deep aero rims as well as with all the normal rims. The professional metal handle gives perfect grip.



GLOBAL	
code	Art.
625552	1751/2DT



## SPRING FOR NIPPLE INSERTION TOOL



GLOBAL	
code	Art.
623300	1751.1/7T

## SPEED NIPPLE BIT



Works with conventional nipples

Threading nipples to the spokes is the most time consuming part of building wheels. Thanks to the speed nipple bit you can now do it with the cordless screwdriver, save yourself some time and still have all the nipples threaded on the spokes to the same depth.

A protruding part in the center of the speed nipple bit keeps the nipple centered and prevents the tool from slipping off it. Eventually, as the nipple is fully threaded down the spoke, the protruding part of the tool touches the approaching spoke and unseats the driver. This enables that all the nipples are threaded down the spokes to the same depth, which leaves you with the perfect starting point to build great wheels.

GLOBAL		
code	Art.	dim
626981	1756	1,5
626982		2,5



## DT SWISS PRO SPOKE WRENCH



Unior's 1630/4DTPR is used for DT Swiss torx profile nipples. The ergonomic design makes work easy and efficient.

GLOBAL		
code	Art.	dim
623448	1630DT/4PR	TX20

## PRO SPOKE WRENCH



- material: special tool steel, hardened and tempered
- handle plastic dipped

The spoke wrench is designed to tighten nipples with flat diameters of 3.3 and 3.45 mm. The ergonomic design makes work easy and efficient. The 3.3 mm wrench has blue plastic coating while the 3.45 mm wrench has grey plastic coating.

GLOBAL		
code	Art.	dim
615532	1630/2P	3.3
615533		3.45



## DOUBLE SIDED SHIMANO® SPOKE WRENCH



- material: special tool steel, hardened and tempered
- surface finish: chrome plated according to ISO 1456:2009
- the key body is plastic-coated

Shimano Spoke wrench is used for nipples with dimensions 4.3 and 4.4 mm on Shimano® Wheel System. Plastic-coated body enables comfortable tightening and unscrewing of the nipples. The length of the wrench is 100 mm, which enables access to the nipples which are mounted on the wheel hub.

GLOBAL		NORTH AMERICA		dim
code	Art.	code	Art.	
618410	1634/2P	624951	1634/2P-US	4.3x4.4

## MAVIC R-SYS NIPPLE WRENCH



Unior's 1635/2AP Mavic spoke wrench is used for nipples with a 5.65mm outside diameter found on the new Mavic R-sys wheels. Plastic-coated body enables comfortable tightening and unscrewing.

GLOBAL		NORTH AMERICA		dim
code	Art.	code	Art.	
623449	1635/2AP	624940	1635/2AP-US	6.8

## MAVIC SPOKE WRENCH



- material: special tool steel, hardened and tempered
- surface finish: chrome plated according to ISO 1456:2009
- the key body is plastic-coated

The smaller end is used for nipples with a 6.4mm outside diameter, while the larger end is used for assembling and disassembling for tubeless Mavic rim inserts. Plastic-coated body enables comfortable tightening and unscrewing of the nipples.

GLOBAL		NORTH AMERICA		dim
code	Art.	code	Art.	
618411	1635/2P	624952	1635/2P-US	6x10.9



## DOUBLE SIDED SPOKE WRENCH

- material: special tool steel, hardened and tempered
- surface finish: chrome plated according to ISO 1456:2009
- the key body is plastic-coated

This wrench is used for nipples with 5 mm and 5.5 mm dimensions. Plastic-coated body enables comfortable tightening and unscrewing of nipples.

GLOBAL		NORTH AMERICA		dim
code	Art.	code	Art.	
619718	1636/2P	624953	1636/2P-US	5,5.5



## DOUBLE SIDED SPOKE WRENCH

- material: special tool steel, hardened and tempered
- surface finish: chrome plated according to ISO 1456:2009
- the key body is plastic-coated

Spoke wrench is used for nipples with dimensions 4,0 and 4,4 mm + 3,3 and 3,45 mm . Plastic-coated body enables comfortable tightening and unscrewing of the nipples.

GLOBAL		NORTH AMERICA		dim
code	Art.	code	Art.	
620179	1633/2P	624949	1633/2P-US	4x4,4
622789		624950		3.3x3.45

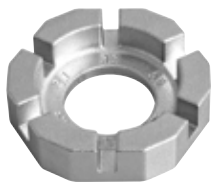

## ROUND SPOKE WRENCH

- material: special tool steel
- drop forged, entirely hardened and tempered

This wrench fits the popular spoke nipple flat sizes: 3.3 mm, 3.45 mm, 3.7 mm, 3.96 mm, 4.4 mm and 5mm. The shape adjusts perfectly to the hand and allows a comfortable work and easy grip.

GLOBAL	
code	Art.
616289	1631/2



## SPOKE WRENCH

- material: carbon steel

Spoke wrenches are designed to tighten nipples with flat diameter 3.3 mm to 3.45 mm. The form of wrench enables a perfect fit to the nipples without slippage and ensures efficient work.

GLOBAL		
code	Art.	dim
616759	1630/2A	3.3
616845		3.45

## SOCKET WRENCH WITH T-HANDLE



- material: blade - chrome vanadium, entirely hardened and tempered
- surface finishing: blade chrome plated according to ISO 1456:2009
- handle - polypropylene

These wrenches have fixed sockets from 5.5 mm to 17 mm. The ergonomic shape ensures comfortable and easy use.

GLOBAL		NORTH AMERICA		dim
code	Art.	code	Art.	
608283	193N	625120	193N-US	5.5



## SOCKET WRENCH WITH TBI HANDLE

- blade: chrome-vanadium-molybdenum steel, entirely hardened and tempered
- blade chrome plated
- handle: ergonomic shape
- three component material
- hanging hole
- made according to standard DIN 3125

GLOBAL		NORTH AMERICA		dim
code	Art.	code	Art.	
612672	629TBI	625213	629TBI-US	5.5





## HUB GENIE



Hub Genie is a unique solution for removing hub end caps while servicing the hubs or converting them to different standards. Thanks to the expanding mechanism, which grabs the hub cap evenly from the inside, even the most stubborn hub end caps are easy to pull-off. Compared with the traditional way of removing hub end caps, this tool won't damage cups or hub. Simply genius.

The tool is available in two versions; smaller one that covers hubs with 12 mm & 15 mm through axles and bigger version that works with 20 mm through axle hubs. Both versions feature plastic dipped handle for better ergonomics and grip.

GLOBAL		
code	Art.	dim
627271	1758	F120
627272		F112-15



## SPOKE TENSION METER

Unior's universal spoke tension meter measures the spoke tension on any kind of spoke. The analog spoke tension meter arrives calibrated and ready to use. To use, simply press the handle, position the spoke between the two pins and release the handle. The properly designed gauge is easy to read. Measured value, needs to be checked in the spoke information table, from where you read the actual tension, based upon the spoke specification. The printed table is included with the tool, together with more precise usage instructions. Additional included feature on the tool is also a spoke thickness gauge, which helps with the whole process. Simply insert the spoke in one of the upper openings and read the spoken thickness value. See the instruction manual for more details.

GLOBAL	
code	Art.
623302	1752/2



## WHEEL ALIGNMENT GAUGE

- material: construction steel, stainless steel and PE-polyethylene

The true checking tool is a tool designed to check the axle symmetry between the hub and the wheel rim. First we set an appropriate distance between the slides according to the wheel size. We lean the middle rest against the nave axle and put the frame with slides nearer to the rim so that the slides touch the rim. Then we fix the rest with a screw and check the other side of the wheel. This enables us to see if the nave is centered according to the rim. If the wheel is not centered, it needs to be trued up.

Precisely manufactured tools enable simple checking of wheels with dimensions from 16 to 29 inch, with or without tire.

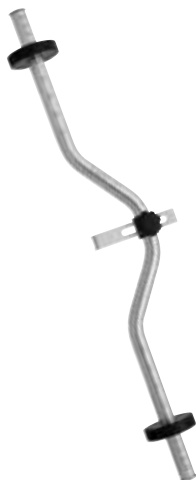

GLOBAL		
code	Art.	dim
618486	1690/1	16" - 29"

## FLAT SPOKE HOLDER

- material: polyamide



GLOBAL	
code	Art.
617588	1632

## SPOKE, BEARING AND COTTER GAUGE

This easy to use tool enables us to measure spokes dimensions and bearing and crank cotter diameters.



GLOBAL		
code	Art.	dim
620561	1629	357.5

## AXLE VICE



- material: special tool steel, hardened and tempered
- surface finish: chrome plated according to ISO 1456:2009

The vice features two different diameter receptacles of 9 mm and 10 mm for inserting front or rear axles. Fits into jaws of engineers vice. The axle vice is easy to use. Two inserted springs will open the jaws automatically when axle vice is removed from engineers vice.

GLOBAL	
code	Art.
619715	1639/2

## CONE WRENCH, SINGLE SIDED



- material: special tool steel, hardened and tempered
- surface finish: chrome plated according to ISO 1456:2009

The design and dimensions of our tools always adapt to new standards and bicycle models. The single sided cone wrench has a remarkable toughness, hardness, durability and tight fit. The ergonomic shape ensures good functionality. The cone wrench sits perfectly in the hand which makes the work fast and comfortable.

GLOBAL		NORTH AMERICA		dim
code	Art.	code	Art.	
615518	1617/2DP	624920	1617/ZDP-US	13
615519		624921		14
615520		624922		15
615521		624923		16
615522		624924		17
615523		624925		18
615524		624926		19
615525		624927		20
617840		624928		22
621918		624965		23
617841		624929		24
619554		624964		27
624134				28
615367		624938		30
615368		624915		32
615369		624955		34
615370		624916		36
615371		624956		40
615456				42
615457				44
623257		624966		1/2"
623258		624972		9/16"

## CONE WRENCH SET



GLOBAL		
code	Art.	dim
624042	1617/2DPPB	13, 14, 15, 16, 17, 18, 19, 20, 22, 23, 24, 28

## HUB CONE WRENCH

- material: special tool steel, hardened and tempered
- surface finish: chrome plated according to ISO 1456:2009

The hub cone wrenches are intended for the home mechanics or professional users. The extreme thin design with pen end jaw fit four popular sizes. These cone wrenches are used by every cyclist for quick repairs and daily maintenance of bicycles.



GLOBAL		
code	Art.	dim
615125	1612/2	13/14x15/17
615126		13/14x15/16



## CONE WRENCH SET



GLOBAL		
code	Art.	dim
615120	1612PB	13/14 x 15/17, 13/14 x 15/16



**R**

**TIRE & TUBE TOOLS**



## SET OF TWO TIRE LEVERS

Set of two tire levers enables you to easily remove tires. They are made from firm plastic and enable work without any damages made to the rim. Useful for every professional mechanic or home user.

GLOBAL		
code	Art.	dim
621984	1657BLUE	blue
624142	1657BLACK	black
624143	1657GREEN	green
624144	1657RED	red



## SET OF TIRE LEVERS IN A BOX, 27 PAIRS

- Set of 27 tire levers can be placed in a bicycle shop on the counter next to the cashier.
- Tire levers are fixed in a high quality cut out foam which can be refilled and reused for several times.
- Set includes blue, black, red and green tire levers.
- On the back side of the box you can find bar codes for each of the four items.

GLOBAL		NORTH AMERICA		dim
code	Art.	code	Art.	
624089	1657ST	626988	1657ST-US	/27



## SET OF TIRE LEVERS, 27 PAIRS

GLOBAL		NORTH AMERICA		dim
code	Art.	code	Art.	
625044	1657STR	627270	1657STR-US	/27

## TIRE SETTER



- material: chrome vanadium
- drop forged, entirely hardened and tempered
- surface finish: chrome plated to standard ISO 1456:2009
- double plastic dipped handles

The pliers are intended for fast straightforward tire removal - especially tires that have already bonded with the rim. Using the pliers, we compress the tire so that it detaches from the bead of the rim. A strong grip facilitates the removal of the tires. The well designed shape of the pliers enables the separation of the tire from the rim and ensures that the inner tube is not punctured when removing the tire. The pliers are chromed and laminated with plastic for a more comfortable grip.

GLOBAL		NORTH AMERICA		dim
code	Art.	code	Art.	
617586	1601/2DP	624948	1601/2DP-US	300



## SET OF TWO METAL TIRE LEVERS

- material: Sheet metal
- surface finish: chrome plated according to ISO 1456:2009

Metal tire levers are used on wheels where mounting and dismounting the tires with plastic tire levers is difficult or impossible.

Unior's 1657/2A tire levers can be stuck behind the spoke, with help of the hook on the end of the lever.



GLOBAL	
code	Art.
623387	1657/2A

## TIRE TREAD CUTTER



The Tread Cutter is the first of a kind plier designed to cut tire treads and was developed specifically for MTB tires. The main benefit of the pliers is the cutting height adjustment slider, which enables cutting of each tread on the same height and therefore making the custom tire the most optimal.

Cutting tires produces more optimal riding. For example shortening centre treads on a mud tire, results for easier rolling. Or the transition lugs in the shoulder area can be trimmed, giving more free space, and making the tread more aggressive. Lugs that have been worn "round" can have a straight edge again.

GLOBAL	
code	Art.
624835	2730/4BI



## BIKE FRAME SPREADER TOOL



- material: special tool steel, hardened and tempered
- ergonomic heavy duty double component handle
- surface finish: chrome plated to standard ISO 1456:2009

The bike piners are designed for quick and easy removal of bike tires and tubes on older and city bikes with metal frames.

The long handle enables you to generate sufficient force to loosen the rims allowing you enough space to simply remove the tire or tube from the wheel without having to dismount the entire wheel. Thanks to its spring lock, the tool will always remain in position allowing you to use it single handedly.

GLOBAL		NORTH AMERICA	
code	Art.	code	Art.
620077	1678/2BI	624944	1678/2BI-US





S

## WHEEL TRUING STANDS & ACCESSORIES

UNIOR 1689



## PRO TRUING STAND



- material: special tool steel

The calipers enable simultaneous radial control of the wheel position on both sides, with an additional possibility to control radial symmetry in relation to the hub.

The geometry of the calipers enables a simultaneous axial control for accurate truing of the rim. The calipers have plastic coated tips to prevent scratching the rim.

The upright arms position can be adjusted with an upright adjustment knob to fit the axle width. The caliper arm position can be adjusted to fit the wheel radius and the caliper tip distance can be adjusted to fit the rim width.

When changing the wheel, the spring loaded upright arms and the caliper arm can be quickly pulled away, automatically springing back to a set position when inserting a new wheel. This enables faster truing of several same size wheels.

Accepts wheels from 16 to 29 inch with or without tire.

Truing of 20 mm or other dimension axle wheels requires additional adapters.

Truing control of brake rotors can be done with additional calipers inserted into slots in the upright arm.

1689 professional wheel centering stand arm can get out of center after being used frequently.

Controlling caliper arm enables us, to calibrate the stand arm back to its center position.

Supports hubs up to 157 mm width.

Additional holes are useful for storing all the three dimension hubs inserts 1689.3 (12, 15 and 20 mm).

Additional nuts in the bottom part of the stand enable easy tightening to a workbench.

### GLOBAL

code	Art.
623059	1689

## PORTABLE TRUING STAND



- material: special tool steel
- supports hubs up to 157 mm width

This stand is intended especially for the enthusiast. It is very easy to use, light (2.3 kg) and does not take up much space. The left bracket is fixed and welded to the lower profile, while the right bracket is flexible to different all axle widths.

The stand can be folded by folding the leg to the lower profile.

The stand can also be mounted on the work bench with screws to increase stability.

It is possible to center wheels with dimension from 16 to 29 inch, with or without tire.

The control sensor is single sided so first the wheel shall be centered on one side, then turned around and centered on the other side.

The additional function enables true checking of wheel discs.

### GLOBAL

code	Art.
623060	1688

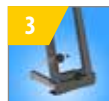
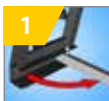



## POCKET WHEEL TRUING TOOL

Home users, cycling team mechanics, world travelers and others cyclist can use the Unior 1753/6 truing tool to work on wheels anywhere they go. With the velcro strap the tool can be mounted to any front fork and rear seat stay of the frame.

The indicator is then used normally as on other truing stands. The tool can be also used for truing rotors.

The 1753/6 pocket truing tool is light and small and easily fits in any back pack.

GLOBAL	
code	Art.
623310	1753/6



## RIM CALIPER FOR 1688

Spare part for 1688 wheel centering stand for home use.

GLOBAL	
code	Art.
621616	1688.2



## ROTOR TRUING GAUGE

Brake caliper is used on the 1689 professional wheel centering stand.

It enables us true checking of brake discs.

GLOBAL	
code	Art.
622603	1689.2

## PRO TRUING STAND CALIBRATION TOOL

1689 professional wheel centering stand arm can get out of center after being used frequently. Controlling caliper arm enables us, to calibrate the stand arm back to its center position.



GLOBAL	
code	Art.
621615	1689.1

## AXLE ADAPTOR

Adapter for truing wheel sets.



GLOBAL		
code	Art.	dim
623004	1689.3	12
623005		15
621617		20

## CANNONDALE LEFTY® ADAPTER FOR TRUING STAND

Unior's 1689.6 Lefty adapter is used for truing Cannondale's Lefty® front wheels, which have specific asymmetric shape and dimension and therefore cannot be used on the centering stand with normal adapters.



GLOBAL	
code	Art.
623450	1689.6

## FAT BIKES CALIPERS FOR PRO TRUING STAND

Calipers for fat bikes are compatible with Unior professional truing stand 1689. Calipers support wheel truing of rims from 50 – 100mm width with tires up to 5.0 width.



GLOBAL	
code	Art.
626456	1689.7

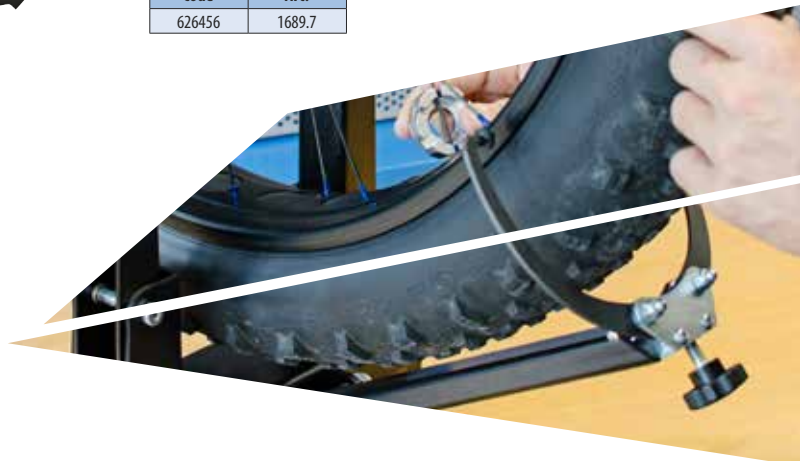

## SPARE TIP FOR CALIPER

Spare plastic tip for calipers 1688.2, 1689.2, 1689.4 on stands 1689, 1688.



GLOBAL	
code	Art.
623256	1689.5

## CALIPER FOR 29 INCH WHEELS FOR 1689

Spare part for 1689 wheel centering stand that enables centering of all the 29 inch wheels without removing the tire.



GLOBAL	
code	Art.
623061	1689.4



**REPAIR STANDS & ACCESSORIES**

**T**

## BIKEGATOR FOLDING STANDS

The bike repair stand is the basic working tool both for service workshops and cycling enthusiasts.

The stand features a new array of precision aluminum and steel parts which offer stiffness and durability.



AUTO-ADJUST



MANUAL-ADJUST



QUICK RELEASE



GLOBAL		NORTH AMERICA		1	2	3	Ø↓	Ø↑	4		
code	Art.	code	Art.								
621470	1693A	625009	1693A-US	X			24 mm	32 mm	X	30 kg	6,5 kg
623222	1693AS	625010	1693AS-US		X		24 mm	40 mm	X	30 kg	6,5 kg
624000	1693A0	625147	1693A0-US	X			24 mm	32 mm		30 kg	5,7 kg
624001	1693AS0	625148	1693AS0-US		X		24 mm	40 mm		30 kg	5,7 kg
627767		1693AQ				X	22 mm	60 mm	X	30 kg	6,5 kg
627768		1693AQ0				X	22 mm	60 mm		30 kg	5,7 kg



## PRO REPAIR STAND WITH SINGLE CLAMP

Repair bike stand is designed for service workshops and every day use.



1 AUTO-ADJUST



2 MANUAL-ADJUST



3 QUICK RELEASE



4



5

GLOBAL		NORTH AMERICA		1	2	3	Ø↓	Ø↑	4	5		📦
code	Art.	code	Art.									
621471	1693B	625011	1693B-US	X			24 mm	32 mm	X	X	30 kg	36 kg
623223	1693BS	625013	1693BS-US		X		24 mm	40 mm	X	X	30 kg	36 kg
623226	1693B1	625012	1693B1-US	X			24 mm	32 mm		X	30 kg	6,8 kg
623227	1693BS1	625014	1693BS1-US		X		24 mm	40 mm		X	30 kg	6,8 kg
627769		1693BQ				X	22 mm	60 mm	X	X	30 kg	36 kg
627770		1693BQ1				X	22 mm	60 mm		X	30 kg	6,8 kg



## PRO REPAIR STAND WITH DOUBLE CLAMP

Repair bike stand with two jaws is designed for service workshops and more demanding users. Stand enables work for two mechanics at the same time on two bikes.



AUTO-ADJUST



MANUAL-ADJUST



QUICK RELEASE



GLOBAL		NORTH AMERICA		1	2	3	Ø↓	Ø↑	4	5		
code	Art.	code	Art.									📦
622581	1693C	625015	1693C-US	X			24 mm	32 mm	X	X	45 kg	56,5 kg
623224	1693CS	625017	1693CS-US		X		24 mm	40 mm	X	X	45 kg	56,5 kg
623228	1693C1	625016	1693C1-US	X			24 mm	32 mm		X	45 kg	9,04 kg
623229	1693CS1	625018	1693CS1-US		X		24 mm	40 mm		X	45 kg	9,04 kg
623230	1693CS2	625019	1693CS2-US	1X	1X		24 mm	40 mm		X	45 kg	9,04 kg
627771		1693CQ				X	22 mm	60 mm	X	X	45 kg	56,5 kg
627772		1693CQ1				X	22 mm	60 mm		X	45 kg	9,04 kg

## PRO REPAIR CLAMP, AUTO ADJUSTABLE

Suitable for tubes with diameter of min. Ø24 mm and max. Ø32 mm.



GLOBAL		NORTH AMERICA	
code	Art.	code	Art.
621472	1693.1	624913	1693.1-US



AUTO-ADJUST

## PRO REPAIR CLAMP, MANUALLY ADJUSTABLE

Suitable for tubes with diameter of min. Ø24 mm and max. Ø40 mm.

Easy accessible screw enables us, to modify the jaw opening and pressure when closed. The screw can be turned by hand without use of any wrench.



GLOBAL		NORTH AMERICA	
code	Art.	code	Art.
623206	1693.1S	624912	1693.1S-US



MANUAL-ADJUST

NEW!



## PRO SHOP CLAMP

Pro Shop Clamp is Unior's high-end offer for bike shops. It features advanced quick release system that enable quick and efficient work on any bicycle.

Quick release system enables the mechanic to press the jaws by hand, at which point clamp already grips the seat post of a frame with sufficient force to hold the bicycle in place. Rotate the handle and additional tension is applied to the jaws to ensure firm grip.

Clamp can grip tubes of any shape, with diameter of minimum Ø22mm to maximum Ø60mm. Pro Shop Clamp has a quick release button, which is used to release the jaws after initial tension release with the rotating handle.

Height of the jaws is 70mm, so it works with smaller sizes of seat posts as well as with dropper posts.

The clamp is compatible with all of Unior's bike stands.

GLOBAL	
code	Art.
627095	1693.1Q



## WALL OR BENCH MOUNT CLAMP

Bench or wall mount option.  
Intended for professional and home workshops.



AUTO-ADJUST



MANUAL-ADJUST



QUICK RELEASE

GLOBAL		NORTH AMERICA		1	2	3	Ø↓	Ø↑	⚖
code	Art.	code	Art.						
622589	1693.2	622589	1693.2-US	X			24 mm	32 mm	3,3 kg
623225	1693.2S	623225	1693.2S-US		X		24 mm	40 mm	3,3 kg
627773		1693.2Q				X	22 mm	60 mm	3,3 kg



## SPARE FOAM FOR TOOL TRAY

Spare SOS foam tray for 1693.3 tool tray.



GLOBAL		NORTH AMERICA	
code	Art.	code	Art.
623821	1693.6	624971	1693.6-US

## TOOL TRAY FOR REPAIR STANDS

The 1693.3 new tool tray consists out of a strong thin metal plate with two rails and an stylish SOS foam tray.

The foam tray is interchangeable, item code 1693.6.

The tool tray fits into the new generation of 1693 stands (made after July 2014). Check with you local distributor for compatibility.



GLOBAL		NORTH AMERICA	
code	Art.	code	Art.
623820	1693.3	624902	1693.3-US

## METAL PLATE FOR 1693B SINGLE CLAMP STAND



GLOBAL	
code	Art.
623231	1693.4B

## METAL PLATE FOR 1693C DOUBLE CLAMP REPAIR STAND



GLOBAL	
code	Art.
623232	1693.4C



## FRAME FOR DOUBLE CLAMP PRO REPAIR STAND, WITHOUT CLAMPS AND PLATE

Build your own bike repair stand with 2 clamps. You can choose between 3 different clamps (1693.1, 1693.1S, 1693.1Q), add a fixed plate to the frame (1693.4C) or just fix the frame into the floor.

GLOBAL			
code	Art.		
623249	1693.5C	45 kg	5,2 kg



## BAG FOR BIKEGATOR BIKE STAND

Strong and quality made bag is intended for protection and carrying of the 1693A (1693AS) BikeGator stand.

It features shoulder and hand straps, two level storage for stand frame and separated jaw and tool tray.

Useful to carry on plane, in the car or just to store in your workshop.

GLOBAL	
code	Art.
624035	1693BAG



## ACCESSORIES FOR SWIVELING VICE JAW 1693.1 AND 1693.1S

GLOBAL	
code	Art.
623205	1693.12



## REPLACEABLE RUBBER COVERS FOR CLAMP 1693.1, 2 PCS SET

GLOBAL		
code	Art.	dim
621961	1693.11	96.5
627266		70

## FIX-IT-YOURSELF BIKE STAND



Fix-it-yourself bicycle repair stand is used in public places: along bike trails, bike parks, campsites, in front of hotels, city centers and other tourist destinations, especially popular with cyclists. Stands are equipped with tools for basic repair and a bicycle floor pump with gauge. On the stand, you can find an adjustable wrench, set of hex wrenches (2.5 – 10), PH and flat screwdriver, cone wrenches sizes 13, 14, 15, 17 and set of tire levers.

Bike can be hung on the stand on the specially designed hangers, protected with rubber.

All tools are attached to a strong wire and when not used, are neatly stored inside the stand frame.

The stand must be bolted to the ground. The bolts are not included.

GLOBAL	
code	Art.
624172	1693E

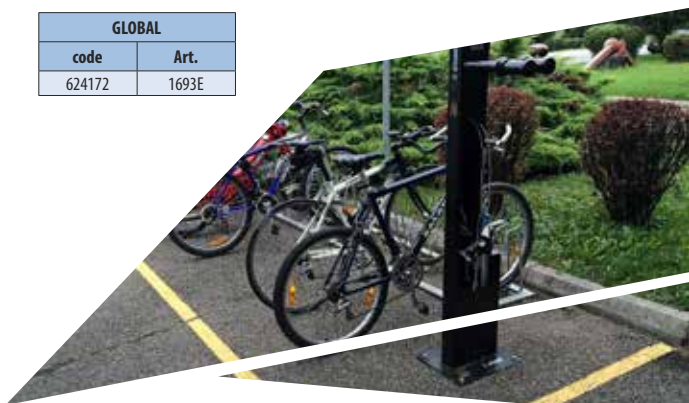

NEW!

## PRO ROAD REPAIR STAND



Pro Road Repair Stand is a sophisticated product, developed in cooperation with some of the best World Tour mechanics.

Stand is built from strong aluminum and steel parts and only weights 5,1 kg.

In comparison to traditional three-leg fork mount stands, Unior's double-leg design takes up less space once unfolded and offers mechanic more working space. Stability of the stand is equal as with three-leg designs.

The upper assembly is angle adjustable, while the complete stand is adjustable by height.

The stand is suitable for work on lighter mountain bikes as well.

The upper assembly is also compatible with Unior's Pro Workshop stands with plate.

The stand can be also upgraded to support bicycles with through axles, with additional through axle adapter – article number 1693R.2.

GLOBAL	
code	Art.
627529	1693R



SHIMANO

U

BIKE STORAGE

## EVENT STAND

Event stand helps you store up to 10 bikes by the saddle. Useful at outdoor races and events as well as for indoor storage.

Event stand can be used in long or short version: Length of useful bike holding area in the long version is 2090 mm and in short version 1260 mm. Width is easily adjustable with a connecting tube.

Stand comes in a compact bag that stores all the parts securely and it's easy to carry around.

Stand is made from aluminum parts and weights only 7.5kg in longer version.

GLOBAL	
code	Art.
625500	1693F

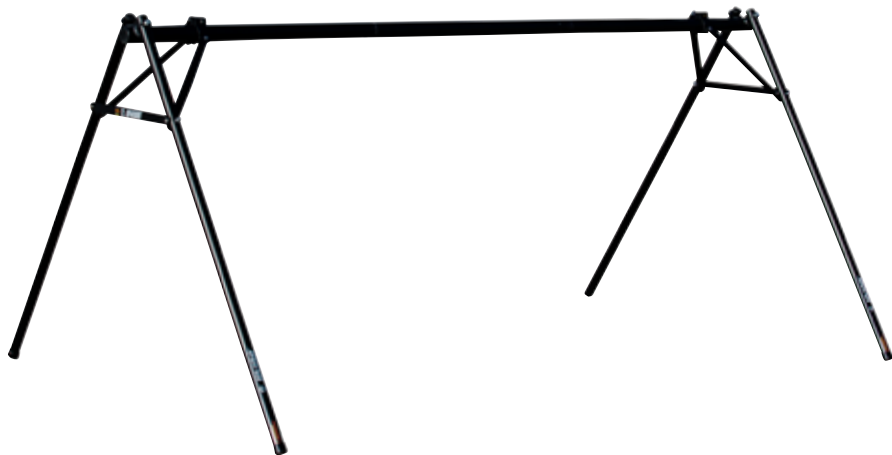

## BANNER FOR EVENT STAND 1693F

Banner is made of durable canvas and is attached to the A frame of the Event Stand with zip ties through metal grommets.

We offer custom banners for your Event Stand 1693F. You can have your company, team or shop logo printed on the banner and get more people to see it.

Contact us for more details about custom banner.



GLOBAL	
code	Art.
627083	TRAN.1693F



## DISPLAY STAND, ADJUSTABLE

Don't hassle with the placement of your bike, leave it in the garage, place it on the shop floor or display it in your living room. Unior's adjustable floor stand is suitable for everything from kid's bicycles to big 29+ monsters. Top part is adjustable in height (for 123 mm) and angle, while the rubber layer protects your frame against scratches. Slot is wide enough to accommodate all popular rear axle dimensions.

Stand is made out of stainless steel and offers great stability, regardless of the bicycle's weight. Base of the stand is equipped with high-quality rubber inserts that prevent movement and protect floor surface. Black finish guarantees compatibility with any style of shop, office or home.



GLOBAL	
code	Art.
626542	1693H



## BIKE LIFT

The bike lift is a simple device which enables a bike to be stored under the ceiling. The lift assembly is fixed to the ceiling. The bike can be raised or lowered by using the rope.

Mounting instructions are enclosed.

Weight capacity: 50 lb or 22,5 kg.



GLOBAL	
code	Art.
618371	1684



**TOOL SETS**

**V**



## BIKE TOOL SET IN TOOL CASE



Pro Kit tool case is real world designed and tested by the professional mechanics on the toughest races around the world.

Well thought out, extremely durable tool pallets organize and hold your tools in place. Pockets are designed with the size of our tools in mind. It also features a few extra pockets leaving you room to personalize your kit.

After designing the tool case for Pro Kit, we sat down with our team mechanics and carefully selected a set of tools that demanding bicycle mechanic will appreciate. We picked 48 pieces of our tools that are a perfect fit for a portable set, shop, home or team mechanics.

GLOBAL		NORTH AMERICA		dim
code	Art.	code	Art.	
627042	1600PROKIT	627358	1600PROKIT-US	/49

## TOOL CASE PROKIT



The toolbox is designed especially for bike tools; it's made of heavy duty plastic and is waterproof and dustproof.

It features a hangout pallet that hooks to the holes on the front side of the case, allowing you to have all your tools at hand. The pallet has 9 pockets that are designed to carry everything from pliers to open end wrenches.

Flaps in the lid can be closed tightly with the Velcro straps; when closed, they also secure the tools in place. Open flaps and inner part of the lid give you 35 individual pockets to carry your tools. The biggest pockets can take our T handle hexes up to size 10 and a special small pockets can securely hold L shaped hex down to size 1.5 or similar small tools, so nothing ever gets lost.

### Advantages:

- The pockets are sewed together with durable nylon thread
- Waterproof and dustproof in accordance with IP67 certificate
- Watertight seal around lid
- Automatic pressure release valve
- Easy to open double throw latches
- Load tested soft grip handle
- Holes for shoulder strap (strap not included in the kit)
- Thick body material
- Nylon pins, corrosion free
- Hang out pallet with 9 pockets, designed to carry everything from pliers to open end wrenches
- Aluminum divider at the bottom of the tool case to keep your tools organized
- Flaps neatly close into the lid of the tool case
- The lid can carry T handle hexes up to size 10
- Special safety tight pockets to hold small tools
- 44 pockets all together + storage under the pallet

GLOBAL	
code	Art.
627041	970PROKIT



## PRO ROAD KIT

Tool kit for the hardcore road rider that likes to keep his bike in perfect order every day! The tools are easy to find in their own customer laser cut S05 foam trays surrounded by a durable Thermoplastic travel and storage box.

**The Pro Road Kit includes the most common tools to keep your bike in top shape:**

- screw type chain tool (suitable for all kind of chains, including Campagnolo 11-speed chains)
- chain wear indicator
- cassette removal and installation tool
- steel wire cutter
- long flat nose pliers
- universal spoke wrench
- set of two tire levers
- set of 9 ball end hexagonal wrenches. Sizes included 1.5, 2, 2.5, 3, 4, 5, 6, 8, 10
- PH Screwdriver
- measuring tape 2m/6ft
- number of pieces in set: 11

GLOBAL		
code	Art.	dim
626543	1600RN	/19



## SUSPENSION SERVICE SET

**The set contains:**

- Bushing extractor set sizes 12 mm and 12.7 mm
- Fork seal installation tool for fork sliders sizes 30, 32, 34, 35/36 and 40 mm
- Hex wrenches sizes 3/64", 1/16", 1.5, 2, 2.5 and 3
- 1/2" sockets sizes 10, 15, 26, 27, 28, 30
- Reversible ratchet
- Strap wrench
- Waterpump box joint pliers

Unior's suspension service set includes the most popular professional tools for servicing forks and shocks, all nicely arranged in a S05 tool tray and stored in a compact box.

GLOBAL		
code	Art.	dim
624041	1704	/27



## MASTER WHEEL BUILDING KIT

GLOBAL		
code	Art.	dim
623441	1754	/16

📦	🔧	📏
1560	15	1
1751/2 (1,2), 1751/2Q (3,35 x 3,35), 1751/2T (1,3), 1629 (357,5), 629TBI (5,5), 193N (5,5), 1633/2P (4 x 4,4), 1634/2P (4,3 x 4,4), 1636/2P (5 x 5,5), 1635/2P, 1635/2AP, 1635/2AP, 1630/4DTPR (TX 20), 1630/2P (3,3, 3,45), 1632, 981PBS3 (346 x 292 x 62)		



## PRO HOME SET

GLOBAL		NORTH AMERICA		dim
code	Art.	code	Art.	
625141	1600CN	625410	1600CN-US	/18

📦	🔧	📏
3800	1K	1
1781/2HX (4 x 5 x 6, 2 x 2.5 x 3), 1781/2TX (10 x 15 x 25), 1647/2ABI, 1720/2DP, 1644/2 (122,5), 1670/2BI (11/12), 1670.8/2BI (350), 220/3L (8), 1609/2BI (350), 1753/6, 1631/2, 1750/2BI, 1666/2DP (2,2), 584/2POLLY (180), 605TBI (1 x 5 x 125), 615TBI (PH 2 x 100), 1657BLUE, 981PB4		

## SET OF BIKE TOOLS 37 PCS



GLOBAL		
code	Art.	dim
622875	1600EN	/37

📦	🔧	📏
7200	1K	1
1609/2BI, 1613/2BI (15), 1666/2DP (2,2), 1657BLUE, 1617/2DP (13, 14, 15, 16, 17), 1630/2P (3,3, 3,45), 1750/2BI, 1660/2, 1661/4, 1670.5/4, 1671.1/4, 1671.2/4, 1682/4, 1647/2ABI, 250/1 (300), 193HX (2,5, 3, 4, 5, 6, 8, 10), 220/3L (2), 193TX (TX 25), 615TBI (PH 1 x 80), 1683/4A (1" x 1.1/8" x 1.1/4" x 1.1/2"), 605TBI (0.5 x 3.0 x 80), 1642.1/2P, 1681/4 (1" x 1.1/8" x 1.1/4"), 1644/2 (), 584/2POLLY (180), AP1		



## SET OF BIKE TOOLS IN TOOL BOX

GLOBAL		
code	Art.	dim
623008	1600E1N	/37

11000	1K	1
<b>1600EN, 911VSOS (95 x 447 x 30), 911/S (460 x 210 x 220)</b>		



## PROFESSIONAL MECHANIC TOOL CARRIAGE

GLOBAL		
code	Art.	dim
627760	1600N1	/127

**1600S0S13, 1600S0S14, 1600S0S15, 1600S0S16, 1600S0S17, 1600S0S18, 1600S0S19, 940EV6 (800 x 440 x 923)**



## SHOP-IN-BOX SET

Set is composed out of 68 commonly used workshop tools for general repairs on a bicycle, stored in a high end tool chest. Tools are divided in five compartments and stored in a high quality SOS foam.

GLOBAL		
code	Art.	dim
624096	1600M	/68

38800	15	1
<b>1600M1 (13), 1600M2 (13), 1600M3 (20), 1600M4 (12), 1600M5 (9), 939/5E (685 x 300 x 535)</b>		



## BIKE TOOL SET IN SOS TOOL TRAY

Set is composed out of commonly used general tools for bicycle repair, such as screwdrivers and pliers. Tools are stored in a high quality SOS foam tray that will fit in any of our 938 or 939 tool chest models.

GLOBAL		
code	Art.	dim
624360	1600M1	/13

1900	1F	1
193TX (TX 10, TX 25, TX 30),  449/1PYTHON (240),  461/1BI (140), 472/1BI (140),  584/2POLLY (180),  605TBI (0.8 x 4.0 x 100, 1.0 x 5.5 x 125, 1.2 x 6.5 x 150),  615TBI (PH 1 x 80, PH 2 x 100), <b>VL1600M1</b> (572 x 270 x 3)		



## BIKE TOOL SET IN SOS TOOL TRAY

Set is composed out of commonly used open and cone wrenches together with a specific pedal wrench. Tools are stored in a high quality SOS foam tray that will fit in any of our 938 or 939 tool chest models.

GLOBAL		
code	Art.	dim
624361	1600M2	/13

1700	1F	1
1612/2A (8 x 9, 10 x 11, 12 x 13, 14 x 15),  1613/2BI (15), 1617/2DP (13, 14, 15, 16, 17, 18, 19), <b>VL1600M2</b> (572 x 270 x 30)		



## BIKE TOOL SET IN SOS TOOL TRAY

Set is composed out of commonly used freewheel tools and set of high quality long hex wrenches. Tools are stored in a high quality SOS foam tray that will fit in any of our 938 or 939 tool chest models.

GLOBAL		
code	Art.	dim
624362	1600M3	/20

2100	1F	1
1670.1/4,  1670.2/4,  1670.3/4,  1670.4/4,  1670.5/4,  1670.6/4,  1670.7/4, 1670/2BI (11/12, 13/14),  220/3SL (1.5, 2, 2.5, 3, 4, 5, 6, 8, 10),  45/2BI, <b>VL1600M3</b> (572 x 270 x 30)		



## BIKE TOOL SET IN SOS TOOL TRAY

Set is composed out of commonly used spoke keys, together with metal and plastic tire levers and other specific bicycle tools. Tools are stored in a high quality SOS foam tray that will fit in any of our 938 or 939 tool chest models.

GLOBAL		
code	Art.	dim
624363	1600M4	/12

📦	🔧	📏
1600	1F	1
<b>1621/1ABI (14), 1630/2P (3.3, 3.45), 1632, 1657/2A, 1657RED, 1666/2DP (2,2), 1750/2BI, 1753/6, 238.7/1 (3/8" - 1/2"), 253/2DP (2,3 x 2,8), VL1600M4 (572 x 270 x 30)</b>		



## BIKE TOOL SET IN SOS TOOL TRAY

Set is composed out of different bottom bracket, crankset and chain tools. Tools are stored in a high quality SOS foam tray that will fit in any of our 938 or 939 tool chest models.

GLOBAL		
code	Art.	dim
624364	1600M5	/9

📦	🔧	📏
2000	1F	1
<b>1609/2BI, 1642.1/2P, 1643/4 (0 - 1,2), 1647/2ABI, 1661/4, 1668/2, 1670.8/2BI, 1671.1/4, VL1600M5 (572 x 270 x 30)</b>		

GLOBAL		
code	Art.	
624091	VL1600M1	SOS tool tray for 1600M1
624092	VL1600M2	SOS tool tray for 1600M2
624093	VL1600M3	SOS tool tray for 1600M3
624094	VL1600M4	SOS tool tray for 1600M4
624095	VL1600M5	SOS tool tray for 1600M5







We took the tools from our Professional Mechanic Work Bench and adopted the SOS inserts to fit drawers of our trolleys. Selection of tools is now available in seven individual trays made of high quality foam (from model 1600S0S13 to model 1600S0S19), where each tool has its own place. Foam trays fit our Europlus, Eurovision, Eurostyle and Hercules trolleys. To better suit your needs each foam tray with tools is available separately.



## BIKE TOOL SET IN SOS TOOL TRAY









GLOBAL		
code	Art.	dim
627160	1600S0S13	/10

 1647/2ABI, 1647.1/4A, 1720/2DP,  1643/4 (0 - 1.2), 1662/4, 1661.3/4P,  1613/2BI (15),  190.1/1ABI (1/2"), 820A (27), 1621/1BI (14 x 15)

## BIKE TOOL SET IN SOS TOOL TRAY



GLOBAL		
code	Art.	dim
627162	1600S0S14	/8

 1609/2BI,  1670/2BI (11/12),  1625/2 (67), 1625/2BB90,  1671.2/4,  1671.1/4, 1602/2,  447/1BI (240)

## BIKE TOOL SET IN SOS TOOL TRAY





GLOBAL		
code	Art.	dim
627164	1600S0S15	/17

 1617/2DP (13, 14, 15, 16, 17, 18, 19, 20, 22, 23, 24, 27)

## BIKE TOOL SET IN SOS TOOL TRAY



GLOBAL		
code	Art.	dim
627166	1600S0S16	/7

 1617/2DP (30, 32, 36),  605TBI (0.8 x 4.0 x 125, 1.0 x 5.5 x 125),  615TBI (PH 1 x 80, PH 2 x 100)



## BIKE TOOL SET IN SOS TOOL TRAY

GLOBAL		
code	Art.	dim
627168	1600SOS17	/25

264 (1/4" x 2-24, 3/8" x 5-110), 220/3 (1.5, 2, 2.5, 3, 4, 5, 6, 8, 10), 220/3SL (3, 4, 5, 6, 8), 236/2HX (8), 236/2HXL (10), 1630/4DTPR (TX 20), 1632, 1630/2P (3.45, 3.3), 1633/2P (4 x 4, 4), 1634/2P (4, 3 x 4, 4), 1636/2P (5 x 5, 5)



## BIKE TOOL SET IN SOS TOOL TRAY

GLOBAL		
code	Art.	dim
627170	1600SOS18	/40

120/1 (6, 7), 129/1 (8, 10, 11, 12, 13, 14, 15, 16, 17, 18), 1657BLUE, 1657/2A, 1781/2HX (2 x 2, 5 x 3, 4 x 5 x 6), 1781/2TX (10 x 15 x 25), 187/2HX (3, 4, 5, 6), 187/2TX (TX 25, TX 27, TX 30), 188.7/2 (1/4" - 3/8"), 188/2 6p (8, 9, 10, 11, 12, 13, 14), 238/1 6p (15), 238.7/1 (3/8" - 1/4"), 1666/2DP (2, 2), 1750/2BI, 1670.1/4, 1670.2/4, 1670.3/4, 1670.4/4



## BIKE TOOL SET IN SOS TOOL TRAY

GLOBAL		
code	Art.	dim
627178	1600SOS19	/19

193TX (TX 10, TX 15, TX 25, TX 30), 193HX (2, 2.5, 3, 4, 5, 6, 8, 10), 193HXS (3, 4, 5), 406/1BI (160), 461/1BI (140), 506/1BI (140), 584/2POLLY (180)

GLOBAL		
code	Art.	
627159	vi1600SOS13	Empty tool tray
627161	vi1600SOS14	Empty tool tray
627163	vi1600SOS15	Empty tool tray
627165	vi1600SOS16	Empty tool tray
627167	vi1600SOS17	Empty tool tray
627169	vi1600SOS18	Empty tool tray
627171	vi1600SOS19	Empty tool tray





**W**

**COMPLETE SERVICE  
SOLUTIONS**

## 2600A Professional Mechanic Workbench

Professional Mechanic Workbench is your choice for the most common bicycle repairs in your workshop. Bench comes with a tool chest with eight drawers and a 2050mm long hard wooden top. Most of the tools are stored in four drawers in a high quality cut-out foam tray. Workbench set comes with a fully equipped truing stand.



**SET1-2600AC**  
625479



Set contains the most common tools for bottom bracket, crankset and chain repairs.

**SET2-2600AC**  
625480



Set contains all cone wrenches of dimensions 13 - 36 and a set of screwdrivers.

**SET3-2600AC**  
625481



Set contains two torque wrenches to cover all the areas on the bike and comes with all the needed bits and sockets. The set includes also several other general tools such as combination wrenches, Three-way and L-shape hex wrenches and some more specific tools such as spoke keys, tire levers, rotor truing tool and others.

**SET4-2600AC**  
625482

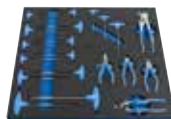

Set contains general tools like T-Handle hex and torx wrenches and pliers.

## 2600B Bike Build Workbench

Bike Build Workbench is the perfect set of tools for bike assembly which come partially assembled in boxes directly from the factories. Workbench comes with a tool chest with eight drawers and a 2050mm long hard wooden top. Most of the tools are stored in three drawers in a compact high quality foam tray. Set also includes a truing stand.



**SET1-2600B**  
625483



Set contains general tools like T-Handle hex and torx wrenches.

**SET2-2600B**  
625484

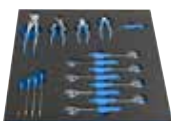

Set contains cone and smaller open wrenches, pliers and tire levers.

**SET3-2600B**  
625485



Set contains general tools for bike assembly such as pedal wrench, screwdrivers, chain tools and other tools.

## 2600C Master Workbench

Master Workbench is a fully equipped workstation for basic and detailed bike repairs. Workbench includes two tool chest units with sum of fifteen drawers and a 2050mm long hard wooden top. Seven drawers are full of tools, stored in a compact high quality foam tray. Set includes a fully equipped truing stand and an IRONGATOR, a vice with quick moving system.



625463

### SET1-2600AC

625479



Set contains the most common tools for bottom bracket, crankset and chain repairs.

### SET2-2600AC

625480



Set contains all cone wrenches of dimensions 13 - 36 and a set of screwdrivers.

### SET3-2600AC

625481



Set contains two torque wrenches to cover all the areas on the bike and comes with all the needed bits and sockets. The set includes also several other general tools such as combination wrenches, Three-way and L-shape hex wrenches and some more specific tools such as spoke keys, tire levers, rotor truing tool and others.

### SET4-2600AC

625482

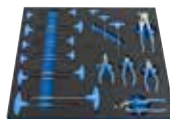

Set contains general tools like T-Handle hex and torx wrenches and pliers.

### SET1-2600C

625486



Set contains several frame specific tools as well as truing stand calibration tool.

### SET2-2600C

625488

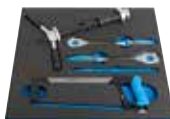

Set contains head set press, hacksaw and freewheel cassette remover

### SET3-2600C

625489



Set contains reamers and cutter for headset and bottom bracket and crown race removal tool.

## 2600D Suspension Workbench

Suspension Workbench is a specific set of tools for servicing bicycle suspension. Workbench comes with a tool chest with eight drawers and a 2050mm long hard wooden top. Three drawers are full with specific and general tools stored in a compact high quality cut out foam. Other drawers are useful for storing spare parts and lubricants. Workbench also comes with IRONGATOR, a vice with a quick moving system and a bench mount bike stand.



625464

### SET1-2600D

625490

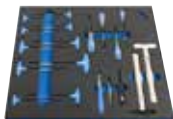

Set contains general tools like T-Handle hex wrenches, selection of screwdrivers, hammers and other small specific tools.

### SET2-2600D

625491



Set contains cone and open wrenches, tape measure and digital vernier and suspension strap with wrench.

### SET3-2600D

625492



Set contains specific selection of pliers for suspension service, fork seal tools, bushing extractor, flat sockets and other tools.

GLOBAL		
code	Art.	
625465	v11-2600A	Empty tray for v11-2600A
625466	v12-2600A	Empty tray for v12-2600A
625467	v13-2600A	Empty tray for v13-2600A
625468	v14-2600A	Empty tray for v14-2600A
625469	v11-2600B	Empty tray for v11-2600B
625470	v12-2600B	Empty tray for v12-2600B
625471	v13-2600B	Empty tray for v13-2600B
625472	v11-2600C	Empty tray for v11-2600C
625474	v13-2600C	Empty tray for v13-2600C
625475	v14-2600C	Empty tray for v14-2600C
625476	v11-2600D	Empty tray for v11-2600D
625477	v12-2600D	Empty tray for v12-2600D
625478	v13-2600D	Empty tray for v13-2600D
627109	vi990WD.NEV	Blank tray for wide work bench drawers 562x570x40
627110	vi990ND.NEV	Blank tray for narrow work bench drawers 374x570x40



**X**

**WORK SHOP A LA CART**





# UNIOR MODULAR WORK BENCHES

**A new line of height-adjustable work benches and modules that adapt to user requirements and the workshop.**



*The wooden work surface can also be protected with a stainless steel worktop.*

High-quality sheet metal – tool carriages, tool boxes, work benches, tool stands, walls, cabinets, drawers, and all other equipment are made of high-quality sheet metal. It is lacquered so as to protect it against mechanical damages and, if used correctly, practically indestructible.

Innovative shape – in addition to quality and durability, Unior equipment is among the best offered in the world due to the innovative design. A comprehensive understanding of the needs of DIY and professional users is evident from the designs that ensure practical accessibility and setting aside of tools as well as a clear overview.

Overview – the excellent overview and easy accessibility offered by the Unior workshop equipment range allows us to easily maintain order and therefore consequently increases workshop productivity.



*The drawers with new slides have a capacity of 50 kilograms.*



*One of the main advantages of the new work benches are the height-adjustable legs.*

**New Unior modular work benches are more adaptable to user requirements.**



*The top elements for plastic boxes and the hanging of small tools.*



*The holder above the work bench for installing a compact LED light.*



*The shelves can be installed horizontally or at an angle of 12 degrees.*



*The wooden work surface is 40 millimetres thick and coated.*



*The doors of bottom elements can open left or right.*

UNIOR

MODULARE





The metal sheet thickness of all supporting parts of modular workbenches is 1 mm, which provides them stability, durability, and diversity of use.



We offer a wide range of accessories for a well-organized workplace.



The parapet channel enables us to electrify the workplace. The standard parapet channel contains 2 sockets, whereas the longer 1500 mm option offers a total of 4 sockets. The parapet channel does not have pre-installed wiring.



The spacious drawer with its 260 mm height is suitable for storing larger items and can be used for sprays storage as well.



The tools stored in the work bench drawers are safely secured with a lock and a folding key.



The LED light with a low power consumption and a high luminosity is available in different lengths. With the attached adapters it is possible to connect the lights together. The light holder can be adjusted by height and depth.



The shelf has a load capacity of 60 kg and has an adjustable two-position incline, which provides a well-arranged and more convenient storing of materials.



By height adjustable leg enables the adaptation of the workbench from a minimum height of 730 mm to a maximum of 1140 mm. The height is adjustable in steps of 30 mm.



The EUROloch perforation allows the usage of most standard accessories. A work bench upgraded with perforated plates offers a variety of layouts and can be adapted to the preferences of the individual user



The connection plate provides maximum stability, even when moving the workbench.



Reinforced rails enlarge greater stability of the drawers with a carrying capacity of 50 kg.



The multilayered 40 mm thick bench top provides high impact resistance and stability in all lengths. The protective layer prevents the absorption of oils and dirt.



Over 300 SOS inserts with tools and inserts for storing of small materials are available for the narrow drawers, as well as for the wide ones. The inserts are combinable or can be custom made upon request.



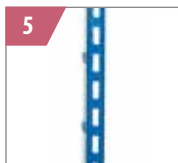

• Available also in black colour

No.	code	Art.		dim
1	625623	990ND8	Tool chest narrow - 8 drawers	
1	625624	990ND2	Tool chest narrow - 2 drawers and door	
2	625620	990WD6	Tool chest wide - 6 drawers	
2	625621	990WD8	Tool chest wide - 8 drawers	
2	625622	990ND6	Tool chest narrow - 6 drawers	
2	625625	990WDD2	Tool chest wide - 2 drawers and door	
3	625630	990TW	Wooden bench top	1500
3	625631	990TW	Wooden bench top	2000
3	625632	990TW	Wooden bench top	2500
3	625633	990TWS	Stainless worktop	1503
3	625634	990TWS	Stainless worktop	2003
3	625635	990TWS	Stainless worktop	2503
4	625656	990HPC	Holder with parapet channel	998
4	625657	990HPC	Holder with parapet channel	1248
4	625658	990HPC	Holder with parapet channel	1498
5	625648	990SL	Left support	
5	625649	990SR	Right support	
5	625650	990SM	Middle support	
5	625651	990SC	Connecting support	
6	625652	990B	Perforated back, 2 pcs set	952
6	625653	990B	Perforated back, 2 pcs set	1202
6	625654	990B	Perforated back, 2 pcs set	1436
7	627088	990CAU	Hanging cabinet for work benches	
8	627069	H.990.WRE	Holder for wrenches	
9	627072	H.990.SCR	Holder for screwdrivers	
10	627371	990.HAM	Holder for hammers	
11	627070	H.990.PLI	Holder for pliers	
12	627604		Set of modular holder for merchandiser with plastic boxes and base plate	
13	625672	990SHELF	Shelf with holders	1000
13	625673	990SHELF	Shelf with holders	1250
13	625674	990SHELF	Shelf with holders	1500
14	625660	990HPB	Holder for plastic box	1000
14	625661	990HPB	Holder for plastic box	1250
14	625662	990HPB	Holder for plastic box	1500
15	625663	990HL	Holder for light with console	999
15	625664	990HL	Holder for light with console	1249
15	625665	990HL	Holder for light with console	1499
15	625667	990LIGHT	Light	900
15	625671	990LIGHT	Light	1200
16	625628	990L	Leg for modular work bench	
16	625629	990LA	Adjustable leg for modular work bench	
17	625626	990NDH4	Tool chest narrow mounted under bench top - 4 drawers	
18	625641	990WDU	Wide tool chest underbase	60
18	625642	990WDU	Wide tool chest underbase	90
18	625643	990NDU	Narrow tool chest underbase	60
18	625644	990NDU	Narrow tool chest underbase	90
19	627074	H.990.PAP	Holder for paper	
20	627068	H.990.BAT	Holder for AKU screwdriver	
21	627073	H.990.TAB	Holder for laptop	
22	625646	990PNE	Power support for modular work bench	
23	625655	990BIN	Cleaning support for modular work bench	

• Please visit [www.unior-bike.com](http://www.unior-bike.com) to see more modular work bench options







940EV1

- 4 drawers (three dimensions 563x365x70mm, one dimension 563x410x150mm)



940EV4

- 7 drawers (five dimensions 563x365x70mm, two dimensions 563x410x150mm)

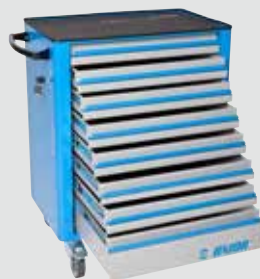

940EV6

- 8 drawers (seven dimensions 563x365x70mm, one dimension 563x410x150mm)



920PLUS1

- 8 drawers (seven dimensions 565x365x70mm, one dimension 565x385x150mm)



920PLUS2

- 7 drawers (five dimensions 565x365x70mm, two dimensions 565x385x150mm)



940H1

- 7 front drawers dim. 564x364 mm (5 height 70 mm and 2 height 150 mm)
- 7 side drawers dim. 374x364 mm (5 height 70 mm and 2 height 150 mm)



940H2

- 7 front drawers dim. 564x364 mm (5 height 70 mm and 2 height 150 mm)



940H3

- 7 front drawers dim. 564 x 364 mm (5 height 70 mm and 2 height 150 mm)

## TOOL CARRIAGE EUROVISION



The lock is installed on the side wall, just under the handle. Thus the key cannot be damaged and due to its flexibility does not cause any obstructions when handling.



Durable 125 mm diameter wheels with a safety brake enable mobility and stability, even if rolled fully loaded over a cable. Proper rolling stability is very useful especially on uneven workshop floors or in the yard.



The 400 mm ball-bearing slides are of higher quality, compared to standard models. This means load capacity increased by 10%, while the drawer still runs smoothly and quietly. Drawers can be taken out easily – with a simple push of the plastic safety buttons.

GLOBAL		
code	Art.	dim
619884	940EV1	800x440x923
619885	940EV4	800x440x923
619886	940EV6	800x440x923

## TOOL CARRIAGE EUROPLUS



Drawer closing mechanism prevents unwanted opening of drawers.



ANTI-SLIP covering offers damage protection for the drawer, as it prevents tools from sliding during opening and closing of the drawer.



Durable 125 mm diameter wheels with a safety brake enable mobility and stability, even if rolled fully loaded over a cable. Proper rolling stability is very useful especially on uneven workshop floors or in the yard.

GLOBAL		
code	Art.	dim
617100	920PLUS1	810x510x945
617101	920PLUS2	810x510x945

## TOOL CARRIAGE HERCULES



The lock is installed on the side wall, just under the handle, enabling better mobility and protecting the inserted key and the lock from possible damage.



Large 125 and 160 mm diameter wheels, two with safety brakes, enable mobility and stability and further reinforce the rolling capacity, which is very useful especially on uneven workshop floors or in the yard.



350 and 400 mm ball-bearing slides are of higher quality, compared to standard models. This means load capacity increased by 10%, while the drawer still runs smoothly and almost inaudibly. The slide design enables the drawers to be taken out easily – with a simple push of the plastic safety buttons.

GLOBAL		
code	Art.	dim
615510	940H1	1182x640x955
615511	940H2	1182x640x955
615512	940H3	1182x640x955



## WORKTABLE

- material: sheet metal
- folding supported legs
- static load capacity: 250kg
- ecological lacquered with cadmium and lead free colour
- plywood – beech wood
- protected with environmentally friendly coating

GLOBAL		
code	Art.	dim
621573	946G	1000x600x850



## MERCHANDISER

- material: perforated steel - plate
- intended for hanging various hand tools on hangers of convenient type
- it is possible to fix the hangers permanently
- easy location of tools
- possibility of combining tool panels of different sizes

The display panel can be fitted on a wall. It is intended for storing various hand tools on hangers of the appropriate type. It is possible to permanently fix the hangers.

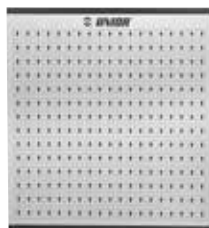

GLOBAL		NORTH AMERICA		dim
code	Art.	code	Art.	
605114	996/2	626484	996/2-US	900x22x972

## SELFSTANDING PANEL

- material: perforated steel - plate
- panel is intended mainly for small shops and workshops

GLOBAL	
code	Art.
621912	976A



## HOOK



- chrome plated

Hooks are useful for boards, display panels and tool cabinets. It is possible to fix the hangers in a required position.

GLOBAL		
code	Art.	dim
609478	997.1	35
609479		50
609480		80
609447		100
610559		150
610560		200

## MERCHANDISER WITH HOLES PERFORATION AND LIGHT



- with two separable support legs
- material: perforated steel - plate
- ecological lacquered with cadmium and lead free colour
- with 100 hooks

GLOBAL		
code	Art.	dim
626607	995DNL	1016x557x2210
626608	995DN1	1000x557x2210
626609	995DN1L	1000x557x2210

## ANGLE MERCHANDISER WITH HOLES PERFORATION

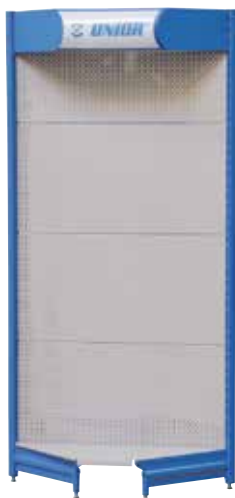

- with two separable support legs
- material: perforated steel - plate
- ecological lacquered with cadmium and lead free colour
- with 100 hooks

GLOBAL		
code	Art.	dim
626610	995VDN	1071x409x2208
626611	995VDNL	1071x409x2208
626612	995ZDN	1009x409x2208
626613	995ZDNL	1009x409x2208



**UNIOR GEAR**

**Y**

## PRODUCTION DEMO SET



GLOBAL	
code	Art.
625164	Demo.bike1

## APRON



GLOBAL	
code	Art.
616497	AP1

## TRUCKER CAP UNIOR, BLUE TRUCKER CAP UNIOR, RED



GLOBAL		
code	Art.	dim
625382	1839B	blue
625383	1839R	red

## T-SHIRT BIKE TOOLS FOR MEN



GLOBAL		
code	Art.	dim
625362	1850M.BIKE.RED	S
625363		M
625364		L
625365		XL
625366		XXL
624150	1850M.BIKE	M
624151		L
624152		XL
624153		XXL

## T-SHIRT BIKE TOOLS FOR WOMEN



GLOBAL		
code	Art.	dim
625367	1850W.BIKE.RED	S
625368		M
624154		M
624155	1850W.BIKE	L
624156		XL
624157		XXL

## T-SHIRT UNIOR SINCE 1919 FOR MEN

## T-SHIRT UNIOR SINCE 1919 FOR WOMEN



GLOBAL		
code	Art.	dim
627712	1850M. UNIOR1919	M
627713		L
627714		XL
627715		XXL
627716	1850W. UNIOR1919	M
627717		L
627718		XL
627719		XXL





## BIKE SHIRT UNIOR

GLOBAL		
code	Art.	dim
619532	15B	S
617628		M
617474		L
617475		XL
617476		XXL



## BIKE SHORTS UNIOR FOR MEN

GLOBAL		
code	Art.	dim
622268	15BM	S
622269		M
617477		L
617478		XL
617479		XXL



## LABEL I LOVE UNIOR

GLOBAL		
code	Art.	dim
625455	1843LOVE	110x32

## LABEL UNIOR BIKE TOOLS

### LABEL UNIOR BIKE TOOLS USA



GLOBAL		NORTH AMERICA		dim
code	Art.	code	Art.	
625456	1843BIKE	625457	1843BIKE-US	90x75

## LABEL UNIOR WRENCH

### LABEL UNIOR WRENCH USA



GLOBAL		NORTH AMERICA		dim
code	Art.	code	Art.	
625458	1843WRECH	625459	1843WRECH-US	100x30

## LABEL UNIOR WHITE



GLOBAL		
code	Art.	dim
626663	1843Unior	121

## LIZARD SKINS LOCK-ON MOAB GRIP



GLOBAL	
code	Art.
617849	1883Moab

## LIZARD SKINS LOCK-ON EXPERT MACHINE GRIP



GLOBAL	
code	Art.
617850	1883Expert

## LIZARD SKINS LOCK-ON BEARCLAW GRIP



GLOBAL	
code	Art.
617851	1883Bearclaw

## BIDON UNIOR



GLOBAL		
code	Art.	dim
621878	1842	0.5l

## CAMELBAK BIDON UNIOR



GLOBAL		
code	Art.	dim
625897	1842ED	0.6l

## CAMELBAK BIDON UNIOR



GLOBAL		
code	Art.	dim
625898	1842PO	0.7l



## BOTTLE OPENER

GLOBAL	
code	Art.
603886	45/2



## BOTTLE OPENER UNIOR WITH BI HANDLE

GLOBAL	
code	Art.
613194	45/2BI



## CUP UNIOR

GLOBAL		
code	Art.	dim
622508	1841	blue
617215	1841RED	red

## UNIOR BICYCLE MECHANICS HANDBOOK



Unior's Handbook from the Canadian author and expert mechanic Denise Belzil, is a detailed book showing how-to instructions with pictures and additional tips for both professional and home bicycle mechanics.

Denise has been working in bicycle mechanics for almost 30 years, becoming one of its pillars in North America. She established Montreal's first bicycle mechanics school, Techno Cycle, during the 1990s, where she has taught countless mechanics during her career.

Volume I cover hubs, bottom brackets and headsets and comes on 274 pages. Volume II covers gear and brake systems on 318 pages.

The book is printed on a high-quality laminated paper with a spiral binding, so it's very handy to use during any bicycle service operation.

The book is available in English and French version.

GLOBAL		
code	Art.	dim
627300	KAT.BIKEBOOK1	2017EN
627302		2017FR
627722	KAT.BIKEBOOK2	EN
627723		FR



## SWEATSHIRT WITH A HOOD SWEATSHIRT WITH A HUT FOR WOMEN

GLOBAL		
code	Art.	dim
622898	1854	S
622897		M
622896		L
622895		XL
622894		XXL
623599	1854W	XS
623600		S
623601		M
623602		L
623603		XL



## NECK RIBBON UNIOR

GLOBAL	
code	Art.
621710	1845



## PAPER BAG UNIOR HAND TOOLS

GLOBAL		
code	Art.	dim
621716	1847SHT	235x370x100

## PLASTIC BAG UNIOR



GLOBAL		
code	Art.	dim
618408	1847PL	235x370x100

## SOS FOAM KEYRING



617917

617918



617920

617921

GLOBAL	
code	Art.
617917	OBE1
617918	OBE2
617919	OBE3
617920	OBE4
617921	OBE5
617923	OBE7
617925	OBE9
617928	OBE12



617923

617925

617928

110/1		Open end wrench	30
110/1CT		Set of combination wrenches, short type in bag	31
125/1		Combination wrench, short type	31
125/1CT		Set of open end wrenches in bag	32
129/1		Combination wrench IBEX	32
129/1CT		Set of combination wrenches IBEX in bag	32
15B		Bike shirt Unior	184
15BM		Bike shorts Unior for men	184
183/2		Offset open ring wrench	97
190.1/1ABI	190.1/1ABI-US	Reversible ratchet 1/2"	33
190.3/1		Sliding T - handle 1/2"	35
190.8/2BI	190.8/2BI-US	Pro Socket Handle 1/2"	36, 93
190/1 6p		Socket 1/2"	36
192/2HX		Hexagonal screwdriver socket 1/2"	37
193HX	193HX-US	Hexagonal head screwdriver with T-handle	17
193HXS	193HXS-US	Ball - end hexagonal screwdriver with T - handle	17
193N	193N-US	Socket wrench with T-handle	38, 127
193TX	193TX-US	TX profile screwdriver with T-handle	18
220/3		Hexagon wrench	20
220/3LPH	220/3LPH-US	Set of hexagon wrenches, long type on plastic clip	22
220/3PB1		Set of hexagon wrenches in plastic box	26
220/3PH	220/3PH-US	Set of hexagon wrenches on plastic clip	26
220/3S		Ball end hexagon wrench	23
220/3SPB1		Set of ball end hexagon wrenches in plastic box	22
220/7TX		Wrench with TX profile and hole	21
220/7TXN		Wrench with TX profile	23
220/7TXPH		Set of wrenches with TX profile in plastic clip	22
220/7TXSPH		Set of ball end wrenches with TX profile in plastic clip	26
236/2HX		Hexagonal screwdriver socket 3/8"	38
238.1/1ABI		Reversible ratchet 3/8"	34
238.3/1		Sliding T-handle 3/8"	35
238/1 6p		Socket 3/8"	37
250/1		Adjustable wrench	33
253.1/4A		Pin set 2 pieces for 253/2DP	41
253/2DP	253/2DP-US	Adjustable spanner wrench	41
264		Click type torque wrench	60
266B		Electronic torque wrench	60
270A		Digital vernier	41
271		Vernier	40
360/6		Tube cutter	111
363		Internal - external reamer	111
406/1BI	406/1VDEBI	Combination pliers	53
442/1HYPO		Variable joint "HYPO" pliers	55
449/1PYTHON	449/1PYTHON-US	Waterpump box joint pliers	55
45/2		Bottle opener	187
45/2BI		Bottle opener Unior with BI handle	187
461/1BI	461/1VDEBI	Diagonal cutting nippers	53

472/1BI	472/1VDEBI	Long flat nose pliers	54
499.1		Plastic jaw for 449/1PYTHON	56
512/1BI	512/1VDEBI	Long nose pliers with side cutter and pipe grip, bent	54
532PLUS/1DP	532PLUS/1DP-US	External lock rings pliers, straight	56, 118
534PLUS/1DP	534PLUS/1DP-US	External lock rings pliers, bent	56, 119
536PLUS/1DP	536PLUS/1DP-US	Internal lock rings pliers, straight	57, 119
538PLUS/1DP	538PLUS/1DP-US	Internal lock rings pliers, bent	57, 119
539PLUS/1DPCT		Set of lock rings pliers PLUS in bag	58, 120
584/2POLLY	584/2POLLY-US	Steel wire cutter	50
605TBI	603VDETBI	Flat screwdriver TBI	39
615TBI	613VDETBI	Crosstip (PH) screwdriver TBI	39
620TBI		Ball-end hexagon screwdriver TBI	18
621TBI	621VDETBI	Screwdriver TBI with TX profile	20
629TBI	629TBI-US	Socket wrench with TBI handle	127
639C		Awl with round, double bent blade	120
639PB		Awl set	120
689/2BI	689/2BI-US	Inner bearing puller	114
710R	710R-US	Measuring tape	40
721.1/6		Swivel base for 721/6 and 721Q/6	48
721/6		IRONGATOR engineer's vice	46
721/6Q	721/6Q-US	Quick IRONGATOR engineer's vice with quick moving system	47
722.1AL		Spare aluminium jaws for 721/6 and 721Q/6	48
750.1CAR		Carbon saw blade for 750B, 2 pcs set	44
750B		Hacksaw	44
760H1/2S		Flat file with handle, half smooth	44
760HB	760HB-US	Flat file with handle, bastard	45
761H1/2S		Half-round file with handle, half smooth	45
762/5 1/2S		Set of files, half smooth in carton box	46
763H1/2S		Round file with handle, half smooth	45
763HB	763HB-US	Round file with handle, bastard	45
764H1/2S		Three-square file with handle, half smooth	45
765H1/2S		Square file with handle, half smooth	45
812		Locksmiths' hammer	42
819A	819A-US	Bumping hammer	43
820A		Bumping hammer	42
920PLUS1		Tool carriage Europlus	176
920PLUS2		Tool carriage Europlus	176
940EV1		Tool carriage Eurovision	176
940EV4		Tool carriage Eurovision	176
940EV6		Tool carriage Eurovision	176
940H1		Tool carriage Hercules	176
940H2		Tool carriage Hercules	176
940H3		Tool carriage Hercules	176
946G		Worktable	178
970PROKIT		Pro Kit Tool Case	154
976A		Selfstanding panel	178
990B		Perforated back, 2 pcs set	174



990BIN		Cleaning support for modular work bench	174
990CAU		Hanging cabinet for work benches	174
990.HAM		Holder for hammers	174
990HL		Holder for light with console	174
990HPB		Holder for plastic box	174
990HPC		Holder with parapet channel	174
990L		Leg for modular work bench	174
990LA		Adjustable leg for modular work bench	174
990LIGHT		Light	174
990ND6		Tool chest narrow - 6 drawers	174
990ND8		Tool chest narrow - 8 drawers	174
990NDD2		Tool chest narrow - 2 drawers and door	174
990NDH4		Tool chest narrow mounted under bench top - 4 drawers	174
990NDU		Narrow tool chest underbase	174
990PNE		Power support for modular work bench	174
990SC		Connecting support	174
990SHELF		Shelf with holders	174
990SL		Left support	174
990SM		Middle support	174
990SR		Right support	174
990TW		Wooden bench top	174
990TWS		Stainless worktop	174
990WD6		Tool chest wide - 6 drawers	174
990WD8		Tool chest wide - 8 drawers	174
990WDD2		Tool chest wide - 2 drawers and door	174
990WDU		Wide tool chest underbase	174
995DN1		Additional merchandiser with holes perforation	179
995DN1L		Additional merchandiser with holes perforation and light	179
995DNL		Merchandiser with holes perforation and light	179
995VDN		Angle merchandiser with holes perforation	180
995VDNL		Angle merchandiser with holes perforation and light	180
995ZDN		End additional angle merchandiser with holes perforation	180
995ZDNL		End additional angle merchandiser with holes perforation and light	180
996/2	996/2-US	Merchandiser	178
997.1		Hook	179
1600CN	1600CN-US	Pro Home Set	156
1600E1N		Set of bike tools in tool box	157
1600EN		Set of bike tools 37 pcs	156
1600M		Shop-in-box set	157
1600M1		Bike tool set in SOS tool tray	158
1600M2		Bike tool set in SOS tool tray	158
1600M3		Bike tool set in SOS tool tray	158
1600M4		Bike tool set in SOS tool tray	159
1600M5		Bike tool set in SOS tool tray	159
1600N1		Professional Mechanic Tool Carriage	157
1600PROKIT	1600PROKIT-US	Bike tool set in tool case	154
1600RN		Pro Road Kit	155

1600SOS13		Bike tool set in SOS tool tray	160
1600SOS14		Bike tool set in SOS tool tray	160
1600SOS15		Bike tool set in SOS tool tray	160
1600SOS16		Bike tool set in SOS tool tray	160
1600SOS17		Bike tool set in SOS tool tray	161
1600SOS18		Bike tool set in SOS tool tray	161
1600SOS19		Bike tool set in SOS tool tray	161
1601/2DP	1601/2DP-US	Tire setter	52, 134
1602/2		Derailleur hanger alignment tool	112
1604.1/2PLUS		Gauge for steerer tube cutting guide	111
1604/2PLUS		Steerer tube cutting guide	110
1607.1/4		Spare head for 1607/4	68
1607/4		Bottom bracket shell installation tool	68
1608/2BI	1608/2BI-US	Bottom bracket wrench 8 notch	65
1609.1		Crank Cap Tool	74
1609.1/2		Crank cap tool metal	74
1609/2BI	1609/2BI-US	Bottom bracket wrench 16 notch	64, 96
1609/2HOBBY	1609/2HOBBY-US	Open bottom bracket wrench 16 notch	65
1610/2		Double ended pedal wrench	79
1612/2		Hub cone wrench	131
1612PB		Set of cone wrenches, 2 pcs	131
1613/2BI	1613/2BI-US	Pro pedal wrench	79
1614/4BI	1614/4BI-US	Crown race puller	107
1616/4		Ball race remover	107
1617/2DP	1617/2DP-US	Cone wrench, single sided	130
1617/2DPPB		Cone wrench set	131
1618/2DP	1618/2DP-US	Offset single sided cone wrench	109
1621/1ABI	1621/1ABI-US	Ratchet wrench	75
1621/1BI	1621/1BI-US	Ratchet wrench	75
1625/2		BB30 removal tool	66
1625/2BB90		BB90 removal tool	67
1626.1A		Campagnolo Power Torque tool set for crank removal and bearing installation	70
1626/2		Campagnolo and Fulcrum Ultra Torque bearing removal and installation set	69
1626A		Campagnolo Power and Ultra Torque full set, also for Fulcrum Ultra Torque	69
1629		Spoke, bearing and cotter gauge	129
1630/2A		Double sided spoke wrench	127
1630/2P		Pro spoke wrench	124
1630DT/4PR		Dt Swiss pro spoke wrench	124
1631/2		Round spoke wrench	126
1632		Flat spoke holder	129
1633/2P	1633/2P-US	Double sided spoke wrench	126
1634/2P	1634/2P-US	Double sided Shimano® spoke wrench	125
1635/2AP	1635/2AP-US	Mavic R-sys nipple wrench	125
1635/2P	1635/2P-US	Spoke wrench, Mavic	125
1636/2P	1636/2P-US	Double sided spoke wrench	126
1639/2		Axle vice	130
1640.1/4		Replaceable pin for chain rivet pliers	52, 87

1640/1DP	1640/1DP-US	Chain rivet pliers	51, 86
1642.1/2P	1642.1/2P-US	Cable puller pliers with lock	50, 97
1643/4		Chain checker, for professional use	87
1644/2		Pro chain wear indicator	87
1647.1/4A		Replacement chain pins for pro chain tools	85
1647/2ABI	1647/2ABI-US	Pro chain tool	85
1647/5MINI		Mini Chain Tool +	86
1647HOBBY/4P	1647HOBBY/4P-US	Chain tool	85
1655EURO6	1655EURO6-US	Multitool EURO6	11
1655EURO7	1655EURO7-US	Multitool EURO7	11
1655EURO13	1655EURO13-US	Multitool EURO13	10
1655EURO17	1655EURO17-US	Multitool EURO17	10
1657/2A		Set of two metal tire levers	134
1657BLACK		Set of two tyre levers, black	133
1657BLUE		Set of two tire levers, blue	133
1657GREEN		Set of two tyre levers, green	133
1657RED		Set of two tyre levers, red	133
1657ST	1657ST-US	Set of tire levers in a box, 27 pairs	133
1657STR	1657STR-US	Set of tire levers 27 pairs	133
1658/2P	1658/2P-US	Sprocket wear indicator	91
1659/2		Chain whip	89
1660/2		Cassette wrench	90
1661.3/4P	1661.3/4P-US	Crank puller with handle	73
1661/4		Crank puller	73
1662/4		Tapered crank puller	74
1663/2BI		Wrench for Saint brake disc nut	96
1664		Crank puller for Shimano® XTR FC-M970	74
1666/2DP	1666/2DP-US	Rotor truing fork	95
1667/2		Chain ring truing fork	76
1668/2		Chainring nut wrench	76
1669/4		2 in 1 pocket spoke and cassette locking tool	93
1670.1/4		Cassette & freewheel tools	92
1670.2/4		Cassette & freewheel tools	92
1670.3/4		Cassette & freewheel tools	92
1670.4/4		Cassette & freewheel tools	92
1670.5/4		Cassette & freewheel tools	92
1670.6/4		Cassette & freewheel tools	92
1670.7/4		Cassette & freewheel tools	92
1670.8/2BI	1670.8/2BI-US	Cassette locking wrench with guide	91
1670.9/4		Cassette locking tool with 12mm guide pin	92
1670/2BI	1670/2BI-US	Cassette wrench	89
1671.1/4		Cartridge bottom bracket tool 20 tooth	70
1671.16N		Bottom bracket socket 16 Notch	63
1671.2/4		Cartridge bottom bracket tool 8 tooth	70
1671.8/2BI	1671.8/2BI-US	Cartridge bottom bracket wrench	66
1671.BB9000		Bottom bracket socket BB9000	63
1671.BBR60		Bottom bracket socket BBR60	63

1671.BSA30		Bottom bracket socket BSA30	63
1671.Mevo		Bottom bracket socket MegaEVO	63
1672/2		Adjustable cup wrench, for older bottom bracket models	67
1678/2BI	1678/2BI-US	Bike frame spreader tool	135
1680/4		Headset press	105
1681.1/4		Head set cup remover, 1 ¼", 1 ½"	106
1681/4		Head set cup remover	105
1682.1/4		Star nut guide	110
1682/4		Star nut setter	109
1683/4A		Crown race setter	106
1684		Bike lift	152
1688		Portable truing stand	137
1688.2		Rim caliper for 1688	138
1689		Pro truing stand	137
1689.1		Pro truing stand calibration tool	139
1689.2		Rotor truing gauge	138
1689.3		Axle adaptor	139
1689.4		Caliper for 29 inch wheels for 1689	140
1689.5		Spare tip for caliper	140
1689.6		Cannondale Lefty® adapter for truing stand	139
1689.7		Fat bikes calipers for pro truing stand	140
1690/1		Wheel alignment gauge	129
1692/4		Dropout alignment gauges	112
1693.1	1693.1-US	Pro repair clamp, auto adjustable	144
1693.11		Replaceable rubber covers for clamp 1693.1, 2 pcs set	148
1693.12		Accessories for swiveling vice jaw 1693.1 and 1693.1S	148
1693.1Q		Pro Shop Clamp	145
1693.1S	1693.1S-US	Pro repair clamp, manually adjustable	145
1693.2	1693.2-US	Wall or bench mount clamp, auto adjustable	146
1693.2Q			146
1693.2S	1693.2S-US	Wall or bench mount clamp, manually adjustable	146
1693.3	1693.3-US	Tool tray for bike stands 1693	147
1693.4B		Fixed plate for 1693B	147
1693.4C		Fixed plate for 1693C	147
1693.5C		Frame for double clamp pro repair stand, without clamps and plate	148
1693.6	1693.6-US	SOS spare tool tray for 1693.3 tray	147
1693A	1693A-US	BikeGator+ repair stand, auto adjustable	142
1693A0	1693A0-US	BikeGator repair stand, auto adjustable	142
1693AQ			142
1693AQ0			142
1693AS	1693AS-US	BikeGator+ repair stand, manually adjustable	142
1693AS0	1693AS0-US	BikeGator repair stand, manually adjustable	142
1693B	1693B-US	Stand with fixed plate and jaw with spring	143
1693B1	1693B1-US	Stand with jaw with spring and without fixed plate	143
1693BAG		Bag for BikeGator bike stand	148
1693BQ			143
1693BQ1			143

1693BS	1693BS-US	Stand with fixed plate and jaw with adjustable nut	143
1693BS1	1693BS1-US	Stand with jaw with adjustable nut and without fixed plate	143
1693C	1693C-US	Repair bike stand with two jaws with spring	144
1693C1	1693C1-US	Stand with two jaws with spring and without fixed plate	144
1693CQ			144
1693CQ1			144
1693CS	1693CS-US	Stand with fixed plate and two jaws with adjustable nut	144
1693CS1	1693CS1-US	Stand with two jaws with adjustable nut and without fixed plate	144
1693CS2	1693CS2-US	Stand with two jaws (with spring and adjustable nut) and without fixed plate	144
1693E		Fix-it-yourself bike stand	149
1693F		Event stand	151
1693H		Display stand, adjustable	152
1693R		Pro Road Repair Stand	149
1694	1694-US	Head tube facing tool 1694	103
1694.1		Head tube reamer	104
1694.2/4		Head tube facing tool frame	103
1695		Frame taps	81
1695.1		Pedal taps	81
1695.1/4BI	1695.1/4BI-US	Handle for reamer and taps	104
1695.1AL		Pedal taps	82
1695.1AR		Pedal taps	83
1695.2		Pedal taps	81
1695.3		Pedal thread inserts, 10 pieces set, right	82
1695.3A		Right pedal thread insert 10 pieces set	83
1695.4		Pedal thread inserts, 10 pieces set, left	82
1695.4A		Left pedal thread insert 10 pieces set	83
1695/4BI	1695/4BI-US	Tap handle	80
1695MB1	1695MB1-US	Crank Saver - Pedal thread repair and insert kit	80
1696	1696-US	Fork threading tool	108
1696.1		Tap for fork threading tool, spare part	108
1696.2		Tap for fork threading tool, spare part	108
1697	1697-US	Bottom bracket tapping tool BSA	99
1697.1		Taps BSA	100
1697.2/4		Adapter for taps BSA	99
1697.3		Set of adapter and taps 1697	99
1697.4		Guide for taps 1697.1 and 1698.1	100
1698	1698-US	Bottom bracket tapping tool ITAL 1698	100
1698.1		Taps ITAL	101
1698.2/4		Adapter for taps ITAL	101
1698.3		Set of adapter and taps 1697	100
1699	1699-US	Bottom bracket facing tool BSA & ITAL 1699	101
1699.1		Bottom bracket reamer	102
1699.2/4		Bottom bracket reamer tool frame BSA & ITA	102
1699.4BSA		Bottom bracket facing tool guide BSA	102
1699.4ITA		Bottom bracket facing tool guide ITAL	102
1699.5/4P		Tool for taps guide for 1699	103
1701/5		Shock bushing extractor set	118

1702		Fork seal driver tool	116
1703/2		Hexagonal wrench for Suntour and RST forks	117
1704		Suspension service set	116, 155
1705/2DP	1705/2DP-US	Suspension wrench with strap	117
1720/2DP	1720/2DP -US	Master Link pliers	51, 86
1721		Universal bearing press set	114
1722/2BI	1722/2BI-US	Universal freewheel remover	90
1750/2BI	1750/2BI -US	Disc brake piston spreader	95
1751.1/7T		Spring for nipple insertion tool, 5pcs	123
1751/2		Nipple driver	122
1751/2DT		DT Swiss® SQUORX nipple tool	123
1751/2Q		Inverted square nipple diver	122
1751/2T		Nipple insertion tool	123
1752/2		Spoke tension meter	128
1753/6		Pocket wheel truing tool	138
1754		Master wheel building kit	122, 156
1756		Speed nipple bit	124
1757/2DP	1757/2DP-US	2-for-1 Disc Brake Tool	96
1758		Hub Genie	128
1780/3G		Ball end hexagon wrench with handle	21
1781/2	1781/2 -US	Y socket wrench	14
1781/2HX	1781/2HX-US	Y hex wrench	14
1781/2HXS	1781/2HXS-US	Y ball end hex wrench	15
1781/2TX	1781/2TX-US	Y torx wrench	15
1782		Bits and sockets set	35, 61
1783/1 6p		Suspension top cap socket	117
1839B		Trucker cap Unior, blue	182
1839R		Trucker cap Unior, red	182
1841		Cup Unior	187
1841RED		Cup Unior	187
1842		Bidon Unior	186
1842ED		CamelBak Bidon Unior	186
1842PO		CamelBak Bidon Unior	186
1843BIKE	1843BIKE-US	Label Unior Bike tools	185
1843LOVE		Label I love Unior	184
1843Unior		Label Unior white	185
1843WRENCH	1843WRENCH-US	Label Unior Wrench	185
1845		Neck ribbon Unior	188
1847PL		Plastic bag Unior	189
1847SHT		Paper bag Unior hand tools	188
1850M.BIKE		T-shirt Bike Tools for men	183
1850M.BIKE.RED		T-shirt Bike Tools for men	183
1850M.UNIOR1919		T-shirt Unior Since 1919 for men	183
1850W.BIKE		T-shirt Bike Tools for women	183
1850W.BIKE.RED		T-shirt Bike Tools for women	183
1850W.UNIOR1919		T-shirt Unior Since 1919 for women	183
1854		Sweatshirt with a hood	188

1854W	Sweatshirt with a hut for women	188
1883Bearclaw	Lizard Skins Lock-On Bearclaw Grip	186
1883Expert	Lizard Skins Lock-On Expert Machine Grip	186
1883Moab	Lizard Skins Lock-On Moab Grip	185
2086	Magnetic tray	40
2600A	Professional Mechanic Workbench	163
2600B	Bike Build Workbench	163
2600C	Master Workbench	164
2600D	Suspension Workbench	165
2620/2BI	Bottom bracket wrench BSA30	70
2650/BI	Pedal Genie	78
2730/4BI	Schwalbe tire tread cutter	135
AP1	Apron	182
Demo.bike1	Production demo set	182
H.990.BAT	Holder for AKU screwdriver	174
H.990.PAP	Holder for paper	174
H.990.PLI	Holder for pliers	174
H.990.SCR	Holder for screwdrivers	174
H.990.TAB	Holder for laptop	174
H.990.WRE	Holder for wrenches	174
KAT.BIKEBOOK1	Unior Bicycle Mechanics Handbook	187
KAT.BIKEBOOK2	Unior Bicycle Mechanics Handbook	187
OBE1 - OBE12	SOS foam keyring	189
SET1-2600AC	Set of tools in tray 1 for 2600A or 2600C	163, 164
SET1-2600B	Set of tools in tray 1 for 2600B	163
SET1-2600C	Set of tools in tray 1 for 2600C	164
SET1-2600D	Set of tools in tray 1 for 2600D	165
SET2-2600AC	Set of tools in tray 2 for 2600A or 2600C	163, 164
SET2-2600B	Set of tools in tray 2 for 2600B	163
SET2-2600C	Set of tools in tray 2 for 2600C	164
SET2-2600D	Set of tools in tray 2 for 2600D	165
SET3-2600AC	Set of tools in tray 3 for 2600C	163, 164
SET3-2600B	Set of tools in tray 3 for 2600B	163
SET3-2600C	Set of tools in tray 3 for 2600C	164
SET3-2600D	Set of tools in tray 3 for 2600D	165
SET4-2600AC	Set of tools in tray 4 for 2600A or 2600C	163, 164
TRAN.1693F	Banner for Event Stand 1693F	151
v11-2600A	Empty tray for v11-2600A	165
v11-2600B	Empty tray for v11-2600B	165
v11-2600C	Empty tray for v11-2600C	165
v11-2600D	Empty tray for v11-2600D	165
VL1600M1	SOS tool tray for 1600M1	159
VL1600M2	SOS tool tray for 1600M2	159
VL1600M3	SOS tool tray for 1600M3	159
VL1600M4	SOS tool tray for 1600M4	159
VL1600M5	SOS tool tray for 1600M5	159
v11600SOS13	Empty tool tray	161

v11600S0S14	Empty tool tray	161
v11600S0S15	Empty tool tray	161
v11600S0S16	Empty tool tray	161
v11600S0S17	Empty tool tray	161
v11600S0S18	Empty tool tray	161
v11600S0S19	Empty tool tray	161
v12-2600A	Empty tray for v11-2600A	165
v12-2600B	Empty tray for v12-2600B	165
v12-2600D	Empty tray for v12-2600D	165
v13-2600A	Empty tray for v13-2600A	165
v13-2600B	Empty tray for v13-2600B	165
v13-2600C	Empty tray for v13-2600C	165
v13-2600D	Empty tray for v13-2600D	165
v14-2600A	Empty tray for v14-2600A	165
v14-2600C	Empty tray for v14-2600C	165
v1990ND.NEV	Blank tray for narrow work bench drawers 374x570x40	165
v1990WD.NEV	Blank tray for wide work bench drawers 562x570x40	165
	Set of modular holder for merchandiser with plastic boxes and base pade	174















